

University of Montana

## ScholarWorks at University of Montana

---

Graduate Student Theses, Dissertations, &  
Professional Papers

Graduate School

---

1974

### Blocking workbook for the beginning director

John Warren Frick

*The University of Montana*

Follow this and additional works at: <https://scholarworks.umt.edu/etd>

**Let us know how access to this document benefits you.**

---

#### Recommended Citation

Frick, John Warren, "Blocking workbook for the beginning director" (1974). *Graduate Student Theses, Dissertations, & Professional Papers*. 1687.

<https://scholarworks.umt.edu/etd/1687>

This Thesis is brought to you for free and open access by the Graduate School at ScholarWorks at University of Montana. It has been accepted for inclusion in Graduate Student Theses, Dissertations, & Professional Papers by an authorized administrator of ScholarWorks at University of Montana. For more information, please contact [scholarworks@mso.umt.edu](mailto:scholarworks@mso.umt.edu).

A BLOCKING WORKBOOK FOR  
THE BEGINNING DIRECTOR

By

John W. Frick

B.A., Colgate University, 1964

Presented in partial fulfillment

of the requirements

for the degree of

Master of Arts

UNIVERSITY OF MONTANA

1974

Approved by:

  
Chairman, Board of Examiners

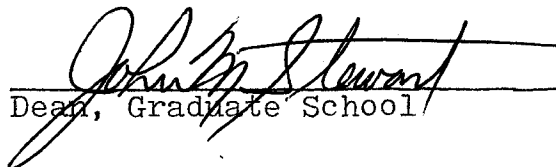
  
Dean, Graduate School

Date Aug 7, 1974

UMI Number: EP35270

All rights reserved

INFORMATION TO ALL USERS

The quality of this reproduction is dependent upon the quality of the copy submitted.

In the unlikely event that the author did not send a complete manuscript and there are missing pages, these will be noted. Also, if material had to be removed, a note will indicate the deletion.



UMI EP35270

Published by ProQuest LLC (2012). Copyright in the Dissertation held by the Author.

Microform Edition © ProQuest LLC.

All rights reserved. This work is protected against unauthorized copying under Title 17, United States Code



ProQuest LLC.  
789 East Eisenhower Parkway  
P.O. Box 1346  
Ann Arbor, MI 48106 - 1346

TABLE OF CONTENTS

	Page
LIST OF FIGURES . . . . .	iv
Chapter	
1. INTRODUCTION . . . . .	1
THE IMPORTANCE OF BLOCKING SKILLS . . . . .	1
THE NEED FOR A BLOCKING WORKBOOK . . . . .	2
CONCLUSIONS . . . . .	7
2. GOALS OF THE WORKBOOK . . . . .	8
LIMITATIONS . . . . .	18
3. CREATING CLEAR COMPOSITIONS . . . . .	20
THE PURPOSES OF COMPOSITION . . . . .	20
INSTRUCTIONS . . . . .	30
4. DESIGNING THE GROUNDPLAN . . . . .	43
THE INFLUENCE OF THE GROUNDPLAN . . . . .	43
INSTRUCTIONS . . . . .	50
5. MOVEMENT AND PICTURIZATION . . . . .	60
INTRODUCTION . . . . .	60
SECTION 1: BLOCKING A SIMPLE STORY . . . . .	63
SECTION 2: MOVEMENT PATTERNS . . . . .	84

Chapter	Page
6. THE USE OF BLOCKING AS A DESCRIPTIVE TOOL . . . . .	92
ANALYZING THE PLAY . . . . .	92
BLOCKING TO ILLUSTRATE THE PLAYWRIGHT'S IDEA . . . . .	101
INSTRUCTIONS . . . . .	105
ANALYSIS OF THE PLAY . . . . .	106
ANALYSIS OF THE SCENE . . . . .	112
7. CONCLUSIONS . . . . .	119
. . . . .	
APPENDIX: READING LIST . . . . .	122
BIBLIOGRAPHY . . . . .	123

## LIST OF FIGURES

Figure		Page
1.	A Composition from a Student Production . . . . .	22
2.	The Corrected Composition . . . . .	25
3.	The Corrected Composition . . . . .	26
4.	The Corrected Composition . . . . .	26
5.	Groundplan for <u>Hedda Gabler</u> . . . . .	46
6.	Groundplan for <u>Arms and the Man</u> , Act II . . . . .	47
7.	Groundplan for <u>Arms and the Man</u> , Act III . . . . .	48
8.	A Descriptive Movement Pattern in <u>Hedda Gabler</u> . . . . .	86

## CHAPTER I

### INTRODUCTION

#### THE IMPORTANCE OF BLOCKING SKILLS

Blocking is so close to the center of the theatrical technique that it cannot be designed effectively without an understanding of some of the most fundamental aspects of the theatre art.<sup>1</sup>

Since a play is created by an author primarily in the form of dialogue and written stage directions, it must be translated into a meaningful and descriptive action so that an audience can clearly comprehend the playwright's ideas in the form in which he intended them to be presented.<sup>2</sup> Equally important, blocking serves as a guide to actors in understanding the characters they are portraying, their relationship to other characters and the underlying ideas of the play. In this sense

. . . blocking . . . is not simply a pictorial process, is not a way of making a performance more beautiful through stage arrangements, but is an inherent activation of the playscript through a body of physical suggestions that can arouse the imagination in actors.<sup>3</sup>

---

<sup>1</sup>David Welker, Theatrical Direction: The Basic Techniques (Boston: Allyn & Bacon, 1971), p. V.

<sup>2</sup>W. A. Gregory, The Director, A Guide to Modern Theater Practise (New York: Funk and Wagnalls, 1968), p. 129.

<sup>3</sup>Francis Hodge, Play Directing (Englewood Cliffs, N. J.: Prentice-Hall, 1971), p. 94.

Given the importance of blocking to the ultimate success of the production, it is imperative that the aspiring director acquire basic blocking skills as early in his formal training as possible.

#### THE NEED FOR A BLOCKING WORKBOOK

The decision to create a blocking workbook grew out of a discussion with Rolland Meinholtz, Associate Professor of Drama and head of directing program at the University of Montana.<sup>4</sup> During this discussion, the following points, which support the need for a workbook approach to basic blocking skills, became clear:

- (1) Students learn a skill best by performing and practicing that skill.
- (2) The existing textbooks on directing do not offer the student sufficient opportunity to "learn by doing."
- (3) Creating a set of exercises which will meet the needs of all students in a directing class is a difficult and time consuming process. It is therefore likely that the teacher-director, considering his teaching and directing duties,

---

<sup>4</sup>Interview with Rolland Meinholtz, Associate Professor of Drama, University of Montana, January 1974.



will simply not be able to devote enough time to constructing a set of problems which will benefit both the student who has never directed and one who has some directing experience.

### The Need to Learn by Doing

The premise that students best learn directing by actually performing the various tasks required of them as directors, that they learn best by doing, is one frequently espoused by authors of textbooks on directing.

Francis Hodge in Play Directing stated emphatically:

Directing lies in doing, and you must find out what to do, where and when to do it, and how to do it to the best advantage . . . Learning directing, as with any art, is a process of personal discovery--doing a thing over and over until they become second nature.<sup>5</sup>

And Viola Spolin's approach to the theater and to actor training is strongly influenced by the principle of individual discovery:

We learn through experience and experiencing, and no one teaches anyone anything. This is as true for the infant moving from kicking to crawling as it is for the scientist with his equations.<sup>6</sup>

---

<sup>5</sup>Hodge, pp. 3-4.

<sup>6</sup>Viola Spolin, Improvisation for the Theater (Evanston, Ill.: Northwestern University Press, 1963), p. 3.

Implied in both statements is the assertion that, although textbooks are invaluable for the vast amounts of information which they provide and the instructor is essential to guide the student toward personal discovery, to advise him and to evaluate his progress, learning takes place only when the individual student personally discovers something which he previously had not known.

Traditionally, the primary means of meeting the directing student's need for practice and experimentation has been the directing laboratory or workshop. However, because of a variety of reasons--the lack of rehearsal space, time, and/or qualified actors; the demands placed upon the instructor's time; and the need to concentrate upon other skills such as pacing or characterization--the actual time spent discovering, developing, or refining basic blocking skills may well be limited to one or two hours per week. And the means for experimentation or practice outside of class or the directing laboratory are even more limited.

#### Limitations of the Existing Textbooks

It might logically be expected that the more popular textbooks on directing might offer a solution to this problem by providing a sufficient number of problems

which will afford the student an opportunity for experimentation and practice. Unfortunately, this is not the case. Upon examination, it was discovered that none of the textbooks frequently used in beginning directing classes provided an adequate number of problems in blocking which the student could solve individually. A survey of five textbooks written especially for the beginning director (as opposed to those books designed for the more advanced student) revealed that their offerings ranged from no problems in a book offering three chapters on blocking to another which offered approximately fifty problems in all.<sup>7</sup>

The following is a summary of the findings in this area.

David Welker, Theatrical Direction: The Basic Techniques: no problems in three chapters--106 pages total.

Curtis Canfield, The Craft of Play Directing: detailed examples of the principles of blocking, but no exercises in two chapters--97 pages total.

W. David Sievers, Directing for the Theater: approximately 40 problems in pre-blocking; 20 on balance, 20 on picturization in one chapter--42 pages.

---

<sup>7</sup>Since beginning this writing, a director's workbook has been published by Stanley Kahan and Harry E. Stiver. Its content and relation to this workbook will be discussed in the conclusions of this thesis.

Francis Hodge, Play Directing: one chapter--24 pages. Numerous problems but intended for class demonstration under the supervision of the instructor (note exercise 2, p. 97 and exercise 1, p. 98), not solution by each student individually.

Alexander Dean and Lawrence Carra, Fundamentals of Play Directing: numerous exercises for classroom demonstration, 10 individual exercises on composition, 43 exercises on picturization.

Clearly, not even the Dean nor Seivers book will suffice if the instructor wishes to devote a full quarter or semester to the study of blocking and wishes to assign homework three nights each week.

#### Meeting the Needs of Students with Different Levels of Skill

Given the limitations of the directing laboratory and the existing textbooks, the directing instructor is practically forced to create his own set of exercises to fill the void. Even if he is able to find enough time, after teaching several classes each day and rehearsing the upcoming show every night, the task is complex. The directing class is likely to be composed of individuals with a wide range of backgrounds and experience, each with separate goals and needs. The directing class given in the fall quarter of 1972, for example, contained several students who had not even directed a French scene, two who had directed at least one full length

play and one student who had directed seven major productions.<sup>8</sup> Obviously, a single set of blocking problems would not have met the needs of each member of this class.

#### CONCLUSIONS

The blocking workbook which follows has been designed, given the stated needs, to provide the student the maximum opportunity to learn by experimentation and practice and to begin work at a level commensurate with his experience and background.

---

<sup>8</sup>Survey of Drama 311, Fall 1972, Robert Ingham, Instructor.

## CHAPTER II

### GOALS OF THE WORKBOOK

To meet each student's needs and serve as an effective tool in learning the complex art of blocking, this workbook will attempt to:

(1) Present a set of blocking problems progressing from simple to complex which will serve as a means of instruction, or rather self-instruction, for the beginning director.

(2) Identify the specific elements of blocking and emphasize their function in the total blocking process.

(3) Develop a positive approach to pre-blocking (blocking on paper prior to rehearsal) and the recording of notes in the director's book.

(4) Encourage constant experimentation as the means to descriptive, dynamic blocking.

(5) To create an awareness, a sensitivity, a "feeling" for the expressive powers of blocking.

#### The Sequential Presentation of the Exercises

The presentation of problems in a progression from simple to complex is a deliberate attempt to

incorporate into this workbook some of the basic elements of programmed learning.<sup>1</sup> Although answers for each problem are not provided (as in many programmed learning books) the workbook allows the student to begin at his own level of skill, progress at his own pace, and to review his work periodically. Like programmed learning books in other fields, this book is student oriented with the instructor serving as a guide or an advisor. It is recommended, although not necessary, that the instructor schedule a short weekly conference with each student to evaluate his progress and suggest a point of concentration for future work. At this time, the instructor may advise the student to advance to the next level of the workbook, spend additional time on the present section, or, if it is apparent that he has failed to grasp the more basic principles, advise the student to review the work done in a previous section. In this manner the learning remains student oriented and the beginning director is not forced to undertake work for which he is not prepared.

---

<sup>1</sup>Secondary School Theatre Conference of the American Educational Theatre Association, Course of Study (n.p.: American Educational Theatre Association, 1963), p. IV.

Identification of the Elements of Blocking

In order for the student to fully understand what is involved in blocking a play, it is necessary to adopt a method common to both the arts and sciences, the dissection and segmentation of the whole to analyze each of the parts individually. Just as the student of zoology dissects the sandshark and catalogues each part of its anatomy and the student of literature concentrates on an author's use of imagery while temporarily ignoring plot structure, characterization or theme, the student of directing must begin his study of blocking by analyzing its separate components--composition, groundplan design, movement and picturization--one at a time.

Since a significant number of textbooks on directing tend to sub-divide the study of blocking into these elements and roughly follow this order of presentation, this workbook will generally conform to this division and order of presentation. Thus, the student will encounter problems in composition in the first section of the workbook; problems in groundplan design in the second; and exercises on movement and picturization in the third. (Movement and picturization, because they are closely related and difficult to grasp individually, have been combined in this workbook.)



Although each chapter has a stated point of concentration, mastery of the elements of previous chapters is necessary. Work on movement and picturization, for example, demands that the student be familiar with composition.

### The Importance of Pre-Blocking

At the core of this workbook is the assumption that pre-blocking is a necessity for the beginning director and a valuable tool of the experienced director.

Possibly the best argument for pre-blocking is that it is a method followed by some of the best known directors in recent theater history. Nikolai Gorchakov in Stanislavsky Directs and Norman Marshall, author of The Producer and the Play have documented the procedure which Constantin Stanislavsky followed early in his career as a director. Quoted in The Producer and the Play, Stanislavsky himself stated:

I used to shut myself up in my study and write a detailed mise-en-scene as I felt it and as I saw and heard it with my inner eye and ear . . . I put down everything in my production notes: in what way a part had to be interpreted and the playwright's stage directions carried out, what kind of inflections the actor had to use, how he had to move about and act, and where and how he had to cross the stage.

I added all sorts of sketches for every mise-en-scene--exits, entries, crossings from one place on the stage to another, and so on and so forth.<sup>2</sup>

A second director, Max Reinhardt, prepared "his Regiebuch [literally, direction book], in which his entire production--line for line, scene for scene, detail after detail--is worked out before the first rehearsal."<sup>3</sup> And

. . . in the margins of the prompt script, [Bernard] Shaw, the director, blocked the action--transforming explicit movements in the text into pictorial patterns or reduced cues, elaborating and refining implicit movements, and inventing new movements that Shaw the author did not indicate.<sup>4</sup>

Although experienced directors, like Stanislavsky as he grew older and more experienced, often abandoned detailed pre-blocking and preferred to allow the blocking to develop "organically" during the rehearsal, the beginning director should avoid this method, especially if working with inexperienced actors who need the security and guidance which well-conceived blocking provides.<sup>5</sup>

---

<sup>2</sup>Constantin Stanislavsky quoted in Norman Marshall, The Producer and the Play (London: MacDonal & Co., 1957), pp. 97-98.

<sup>3</sup>John Gassner, Producing the Play (New York: Dryden Press, 1941), p. 275.

<sup>4</sup>Bernard Dukore, Bernard Shaw, Director (Seattle: University of Washington, 1971), p. 31.

<sup>5</sup>James Roose-Evans, Directing a Play (New York: Theatre Arts Books, 1968), p. 16.

Experienced teacher-directors agree that

For the beginner, it is wise to commit plans to paper. A written plan enables one to avoid inconsistencies and to make careful preparation for all the minutiae of the production.<sup>6</sup>

Therefore, although development of blocking during rehearsal through improvisation may serve as the ideal toward which the student director works, until he gains enough experience to work facilely with an improvisational situation, he should pre-block outside the rehearsal.

This opinion is substantiated by Welker, Hodge, and Canfield in their books on directing methods.

David Welker states:

For most directors, precise planning has great advantages. The absence of distractions is of enormous importance. A related factor is the relaxation provided by not having to work under the pressure of time. A blocking decision which is made during rehearsal must be made very quickly--probably ten minutes is the maximum length of time that a cast can be asked to stand waiting while the director works out some problem. Even if the decisions can be made in that very short period, six such decisions would hold up the work for a full hour--a third of an evening's rehearsal . . . An additional advantage of careful planning is that it frees the director's attention during rehearsal for other things.<sup>7</sup>

Francis Hodge:

There is something about writing down observations one notes about a playscript that particularizes

---

<sup>6</sup>Marian Gallaway, The Director in the Theater (New York: Macmillan Company, 1963), p. 52.

<sup>7</sup>Welker, pp. 187-188.

and pinpoints them . . . by writing down your ideas, you see many more possibilities begin to open up . . . Without adequate formal preparation a young director's work with actors will not only be haphazard but will follow a line of general directing and not of specific directing. A general development is dull and boring, only the specific can hold the attention of an audience.<sup>8</sup>

Curtis Canfield:

What usually happens when the beginning director resorts to improvisation is that each placement and move . . . are tested by the trial-and-error method. This can be a very wasteful and inefficient process. The actors are kept waiting around while the director tries first one move and then another, and then a third and fourth. The actors become confused, the director more so, and sooner or later he may begin to shout to conceal his shame or his incompetence. Eventually, and with luck, the company gropes its way toward some arrangement which may still fail to convey the true dramatic idea. The surest way to make a cast lose confidence in itself as well as in the director is to adopt this fumbling approach.<sup>9</sup>

Briefly stated, pre-blocking aids the beginning director in the following ways:

- (1) It allows him to assess the problems of the play without the pressures of a rehearsal situation.
- (2) It helps him avoid most inconsistencies and be specific in his solution to each problem.

---

<sup>8</sup>Hodge, pp. 62-63.

<sup>9</sup>Curtis Canfield, The Craft of Play Directing (New York: Holt, Rinehart and Winston, 1963), p. 128.

- (3) It allows him to better utilize valuable rehearsal time.
- (4) It helps him avoid losing the confidence of the cast due to poor organization.

#### Experimentation as a Means to Dynamic Blocking

One pit-fall which invariably plagues the beginning director staging his first scene or play is cliché or generalized blocking.<sup>10</sup> This problem most likely results from his settling for an obvious or general solution to a specific situation.

To avoid generalized blocking, the student must be encouraged to create several alternate solutions to the same problem, to critically evaluate the effectiveness of each, and to reject all but the best solution. This trial-and-error method may be more painful and time consuming, but is the only way to avoid generalizations and make blocking more dynamic and expressive.

To this end, the student will be required in this workbook, especially in the chapter on Composition, to design several solutions to each problem, to

---

<sup>10</sup>Observation of scenes prepared by beginning directors for Workshop in Theater, February, 1974.

analyze his solutions, and to select the best blocking. Although only two or three solutions are actually required, the student must realize that the problem is solved only when he is completely satisfied with his work. It is incumbent upon the instructor to ensure that this standard is maintained.

Through an experimental or trial-and-error approach to each blocking situation in this workbook, it is hoped that the student will begin to develop the ability to evaluate and analyze his own blocking, not only in the later chapters of this book, but in all his work as a director.

#### The Development of a "Feeling" for Blocking

The most difficult objective to define and to attain is the development of a feeling for blocking, that intuitive sense which enables a director to select the most expressive, most artistic staging of a script. This sensitivity is normally the result of extensive experience and familiarity with the methods and materials of staging and their possible uses.

Development of sensitivity and awareness of the potential of blocking is the highest goal, not only of this workbook, but of all director training because it is a goal of any artist. It is an awareness or

sensitivity for his medium of expression which enables him to create the beautiful and express the truth as he perceives it.<sup>11</sup>

Although it is debatable whether any instructor, textbook or workbook can accomplish this goal alone, certainly they can provide some of the opportunities a beginning director must have to develop awareness. This workbook attempts to facilitate the development of the student's artistic sensitivity by: (1) supplementing the experience gained in the directing laboratory and actual productions by providing additional creative opportunities; (2) providing a number of basic situations with several variations which require the student to discern the essential characteristics of each scene and express these in his blocking; (3) providing the opportunity to work intensively on plays in which he must develop an artistic concept of the script and then visually express his interpretation.

Although no class work or homework can replace actual directing experience in developing artistic awareness, it is hoped that this workbook will better prepare the student for practical experience and thus accelerate his progress.

---

<sup>11</sup>Gregory, p. 5.

## LIMITATIONS

In order to maintain the focus in this workbook upon the problems of blocking, it will not cover designing scenery, costumes, make-up nor lights; the principles of acting, pacing, casting nor rehearsal organization and techniques. Nor will it include the history of the theatre, the historical development of the director or dramatic styles. It will leave the study of these areas to the instructor of the directing class or textbooks on directing methods and it is assumed that the student will refer to one of these sources when he needs this information for continued progress in the workbook.

For example, the student should study production styles before undertaking the problems in Chapter VI. Exercises in creating the groundplan, however, appear because a workable groundplan which creates an environment for the actors is necessary before the director can undertake the blocking of the play.<sup>12</sup> Likewise, exercises on interpreting the play and its characters have been included because this understanding is essential in order

---

<sup>12</sup>Canfield, p. 130.



for the director to use blocking to clearly express the dramatic values of each scene and the play in general.<sup>13</sup>

The problems in this workbook are based upon the principles of blocking developed for the proscenium stage because a director trained according to the techniques of the proscenium stage "will find it easier to adapt to central staging than would a director trained in the round and adapting to the proscenium stage."<sup>14</sup>

According to Alexander Dean

Most of what has been written about the proscenium stage has direct application to directing for the theatre in the round. Directing on a central stage for an audience in-the-round requires some special adaptations of the techniques involved in directing for the proscenium stage.<sup>15</sup>

---

<sup>13</sup>Gassner, Producing, p. 242.

<sup>14</sup>W. David Sievers, Directing for the Theatre (Dubuque, Iowa: Wm. C. Brown Company, 1965), p. 296.

<sup>15</sup>Alexander Dean and Lawrence Carra, Fundamentals of Play Directing (New York: Holt, Rinehart and Winston, 1965), p. 287.

## CHAPTER III

### CREATING CLEAR COMPOSITIONS

#### THE PURPOSES OF COMPOSITION

At the core of the blocking process is composition, which Alexander Dean defines as "the rational arrangement of people in a stage picture through the use of emphasis, stability, sequence and balance."<sup>1</sup> Stanislavsky describes it simply as "the placement of the actors within the stage settings by the director."<sup>2</sup> To aid in understanding this concept, composition might be compared to painting X's on the stage floor in a meaningful and organized pattern. To complete the blocking process, the director would place actors gesturing and relating to each other on each X (picturization) or move the actors from one X to another (movement). Conceived of in this way, composition

---

<sup>1</sup>Dean, p. 109.

<sup>2</sup>Nikolai M. Gorchakov, Stanislavsky Directs, ed. Virginia Stevens, trans. Miriam Goldina, with a Foreword by Norris Houghton (n.p.: Minerva Press, 1954), p. 400.

"is the form on which the other elements are superimposed."<sup>3</sup> It is the organization, without which, staging would become random, chaotic and meaningless.

Before you can begin to study and employ the principles of composition, however, you must understand what purpose, other than serving as the foundation for the other elements, composition serves.<sup>4</sup> Although textbook writers offer a variety of functions, the list can be effectively reduced to one: to clarify the author's intent for both the actors and the audience.

Anyone who has been present at a play where this function has not been fulfilled is aware that a problem exists, although he is usually unable to identify the specific cause. The problem, however, manifests itself in such statements as, "I could hear him, but I couldn't see his face," "I couldn't tell who was speaking most of the time," "Someone was standing right in front of Hamlet when he was speaking," or "It looked okay at first, but nothing changed. Every scene looked like the one before it.

---

<sup>3</sup>Hodge, p. 192.

<sup>4</sup>Chapters I, II and VII of this thesis are addressed to the instructor. Consequently, in referring to the student, the third person has been used. In chapters III-VI the student is addressed directly which necessitates the use of the second person.



The scene afforded the actor playing the master a wonderful opportunity to "drive home" the playwright's meaning with a scowl or an acidic glance at one of the servants, but since the audience was unable to see his face, the impact of the scene was lost. Nor could the servants' reactions to the reprimand be seen since the master was standing between them and the audience. In addition, the actor who delivered an aside at the end of the scene, was forced to leave the composition entirely, make a rather lengthy cross to the audience and then return to his original position via the same route thus breaking the continuity of the scene.

This example illustrates three ways in which clarity in composition may be seriously impaired: masking, upstaging and lack of emphasis. The latter, emphasis, is one of the principle requirements of clear composition and entails the structure of blocking so that the central character at a given moment receives the attention of the audience when he is speaking or has important business.<sup>7</sup> It is essential in Act V, Scene 2 of Hamlet, for example, that the audience focus their attention on Gertrude when she drinks the cup of poison. Shakespeare reinforces her

---

<sup>7</sup> Kenneth M. Cameron and Theodore J. C. Hoffman, The Theatrical Response (n.p.: MacMillan Company, 1969), p. 303.

drinking with Claudius in the line, "Gertrude, do not drink," (L. 272), but the movement itself must be clearly seen by the audience, unaided by the line, for her death to make sense.

Emphasis can be achieved by a director in a variety of ways: by direct or indirect focus: by grouping actors in one area of the stage and isolating the central character in another; by lowering or elevating him relative to the others on stage; by having the emphasized actor assume a body position different from the other actors, i.e. full front while the others are full back to the audience; or through use of a triangular blocking pattern with the central character at the apex.<sup>8</sup>

Emphasis may also be gained (or aided) by technical means--through lighting, costuming, an attention-getting prop or proximity to a prominent set piece.<sup>9</sup>

Although emphasis on Gertrude when she drinks the poison is guaranteed by the lines which precede and

---

<sup>8</sup>"In direct [focus], characters all look directly at the character receiving the focus . . . In indirect, one character accented by others direct their gaze away from him with the exception of one or possibly two who direct gaze to the one receiving the focus." Albert Johnson and Bertha Johnson, Directing Methods (London: A. S. Barnes & Company, 1970), p. 273.

<sup>9</sup>Ibid.

follow the action, it can be strengthened by the director in several ways: (1) the thrones of Gertrude and Claudius could be elevated above the area where Hamlet and Laertes duel; (2) direct focus on Gertrude by Hamlet and Claudius on Hamlet's line, "Good madam", and (3) a combination of direct and indirect focus by the other members of the court.

The problems of masking and upstaging may be considered a failure to achieve proper emphasis. When the master in the aforementioned scene speaks with his back to the audience, he is in a very weak position to receive emphasis as are the servants when they are masked by their employer.<sup>10</sup> A solution to the problem might be to have the master adopt either a full front or 3/4 position, moving in back or along side of the servants as in the following composition.

Figure 2. Three servants are seated on the sofa, two are standing stage right of the sofa in a 3/4 position and the master (M) is behind the sofa in the full front position.

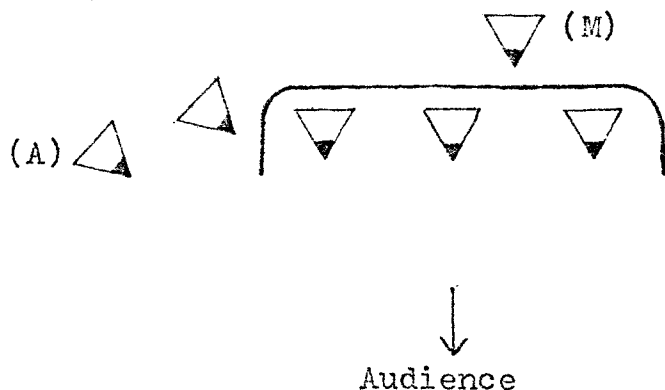

<sup>10</sup>Roose-Evans, p. 53.

Figure 3. The master would be in the full front position on the platform behind his servants. Both this composition and that of Figure 2 have the additional advantage of allowing the servants to react to the master's reprimand unseen by him.

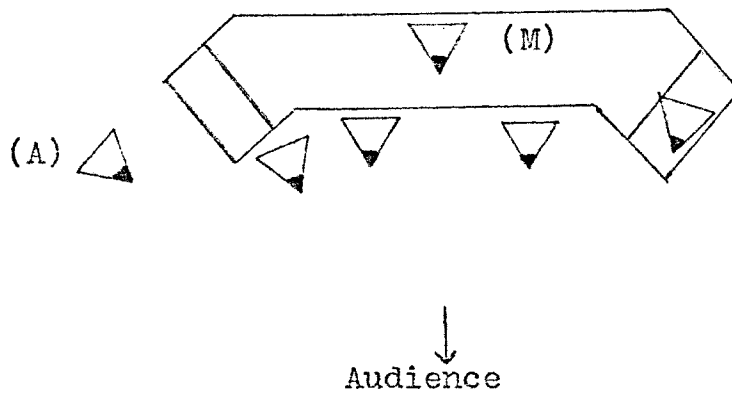
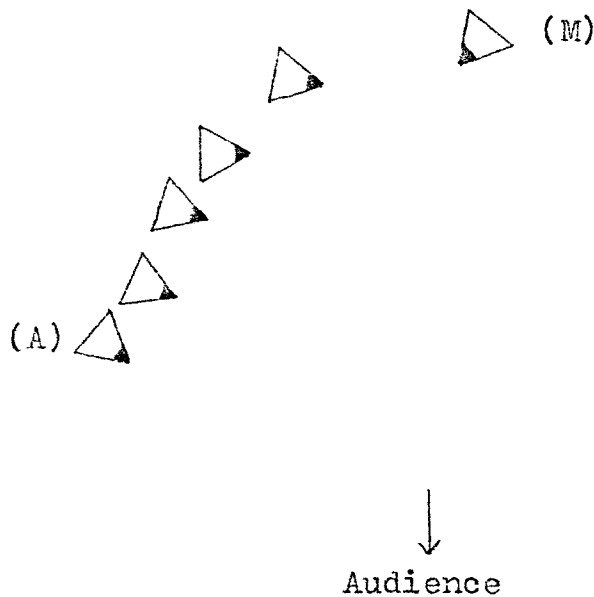

Figure 4. The servants are lined up on a diagonal starting downstage right and tending toward upstage center. The master would address them from the upstage end of the line.





Each of these compositions, in addition to "opening" the actors' positions, emphasizes the master. And the servant who has an aside (character A) can accomplish this by simply taking one or two steps downstage, thus avoiding an unnatural cross. Briefly stated, these compositions enable audience members to clearly perceive the action of the scene.

Clarity: The Actor.

In addition to creating understandable blocking for the audience, well-conceived compositions can clarify the nature of a scene or a relationship for the actors. While staging a recent production of Hedda Gabler this became very clear.<sup>11</sup> Act II had been blocked up to and including the scene in which Hedda and Lovborg, alone in the living room, reminisce about their past relationship and eventually argue about their present one (pp. 386-390, LeGalliene translation). The scene seemed to convey the values the director wanted and the actors appeared comfortable with the blocking, so the next scene was begun. Thea's entrance was "set," Hedda crossed to meet her, Thea tried to cross to Lovborg, Hedda caught her by the

---

<sup>11</sup>Hedda Gabler, produced at the University of Montana, November 7-11, 1973, John Frick, Director, Allen Cook and Rolland Meinholtz, Advisors.

wrist and both sat on the sofa on Hedda's lines, "No, no, little Thea, not there! You be a good girl and sit here, next to me. I'll sit between you." When the director originally blocked the scene at home, the next step was for Lovborg to cross to the sofa on Hedda's command and sit next to her, but suddenly this seemed wrong, very wrong. The scene had been interpreted by the director as a battle of wills between Lovborg and Hedda and consequently for Ejlert to acquiesce would be tantamount to capitulation even before the battle had begun. The audience would be deprived of the opportunity of witnessing his gradual destruction by Hedda, the scenes in Act III would lose their impact and his eventual suicide would become meaningless. Sensing this, the director changed the blocking so that Lovborg remained near the chair stage left and on Hedda's succeeding entreaties, moved even further away to a position behind the chair. The result was startling. The empty space on the sofa next to Hedda seemed to mock her and she became increasingly vicious in her attacks on Lovborg who now held his ground more defiantly than ever. With the battle raging fully now Thea, seated next to Hedda on the sofa, felt left out of the action and new meaning was added to her pleading. Even at this early stage of rehearsal, while they still had the script in their hands, the actors sensed what was

happening in the scene and the stage was alive with conflict.

In blocking the following exercises, you, likewise, must concentrate upon achieving clarity for both the audience and your actors.

INSTRUCTIONS

Each of the following compositions is unclear or inadequate. Based upon your reading, identify the deficiencies of each and then offer alternate compositions which correct the errors and accomplish the stated purpose. Items of furniture or set pieces may be changed or added (unless directions specify otherwise), but the number of characters should remain the same.

In solving the problems in this chapter, you should use the following symbol to represent an actor's position on stage: (The darkened point indicates the direction he is facing.)

Example: A is addressing  
B, C and D.  
A has emphasis.

Deficiencies

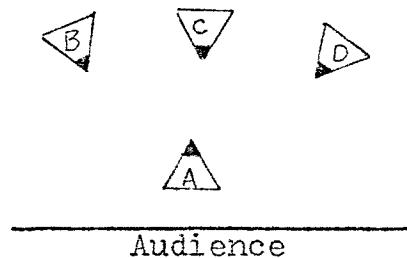

A is forced to speak  
upstage and has poor  
emphasis.

Your Solutions

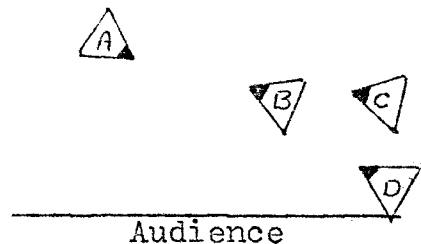
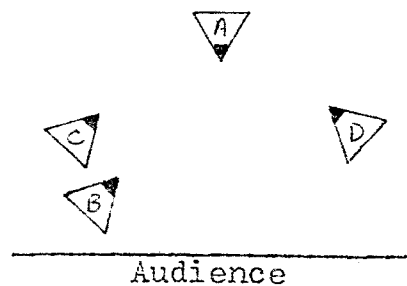

Both solutions eliminate the problem of upstaging and accomplish the given purpose, placing emphasis on A.

A. A and B share the scene.

Deficiencies



\_\_\_\_\_  
Audience

\_\_\_\_\_  
\_\_\_\_\_  
\_\_\_\_\_  
\_\_\_\_\_

Your Solutions

\_\_\_\_\_  
Audience

\_\_\_\_\_  
Audience

B. Character C is speaking to the other characters. C has emphasis.

Deficiencies



\_\_\_\_\_  
Audience

\_\_\_\_\_  
\_\_\_\_\_  
\_\_\_\_\_  
\_\_\_\_\_

Your Solutions

\_\_\_\_\_  
Audience

\_\_\_\_\_  
Audience

C. A is speaking to B and C. A has emphasis.

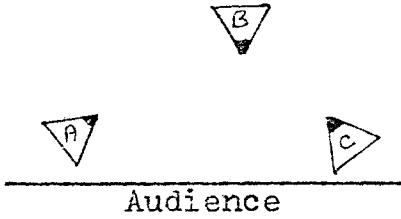

Deficiencies

---



---



---



---

Your Solutions

\_\_\_\_\_  
Audience

\_\_\_\_\_  
Audience

D. A and B share the scene.

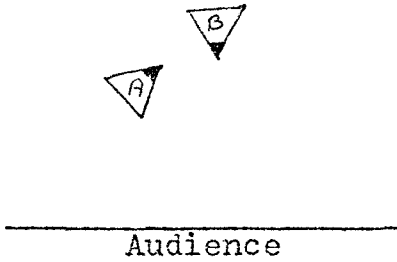

Deficiencies

---



---



---



---

Your Solutions

\_\_\_\_\_  
Audience

\_\_\_\_\_  
Audience

E. A and B share the scene.

Deficiencies



---

---

---

---

---

Audience

Your Solutions

---

Audience

---

Audience

F. A and B share the scene;  
C and D are interested  
bystanders.

Deficiencies

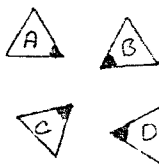

---

---

---

---

---

Audience

Your Solutions

---

Audience

---

Audience

G. B is speaking to C, D and E. B has emphasis.

Deficiencies



Audience

---



---



---



---

Your Solutions

Audience

Audience

H. A is speaking (dramatic monologue).

Deficiencies

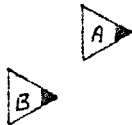

Audience

---



---



---



---

Your Solutions

Audience

Audience



I. A and B share the scene.

Deficiencies

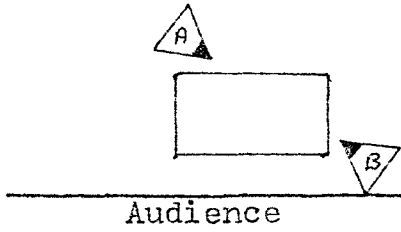

---



---



---



---

Your Solutions

\_\_\_\_\_  
Audience

\_\_\_\_\_  
Audience

J. People at party. A and B in conversation, are dominant and share the scene.

Deficiencies

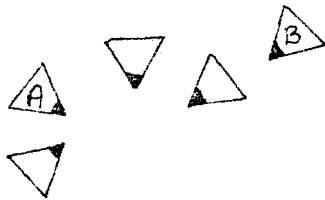

---



---



---



---

\_\_\_\_\_  
Audience

Your Solutions

\_\_\_\_\_  
Audience

\_\_\_\_\_  
Audience

K. A and B share scene.

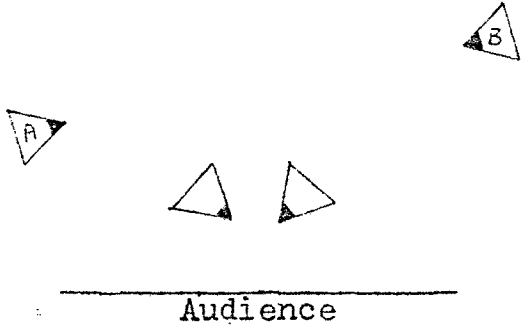

Deficiencies

---



---



---



---

Your Solutions

Audience

Audience

L. A and B share the scene.

Audience

Deficiencies

---



---



---



---

Your Solutions



A diagram for exercise L showing an inverted triangle labeled 'A' pointing downwards.

Audience

Audience

M. A is speaking to C and D. B is disinterested bystander.

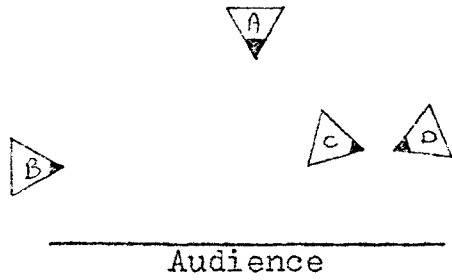

Deficiencies

---



---



---



---

Your Solutions

Audience

N. A and B share the scene and have emphasis. C, D, E, F and G are involved in whispered conversation.

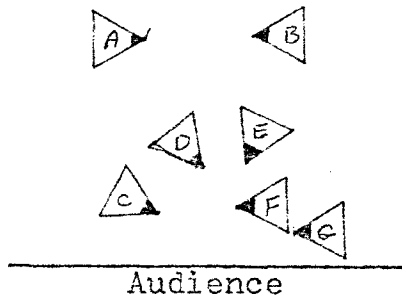

Audience

Deficiencies

---



---



---



---

Your Solutions

Audience

Audience

O. A and D speak to each other during scene. (The same items of furniture, but size and shape may change.)

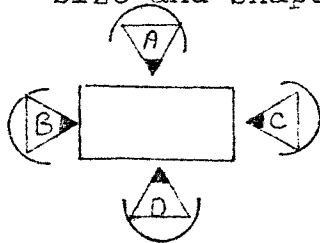

Audience

Deficiencies

---



---



---



---

Your Solutions

Audience

P. A and C share scene; B and D are interested bystanders.

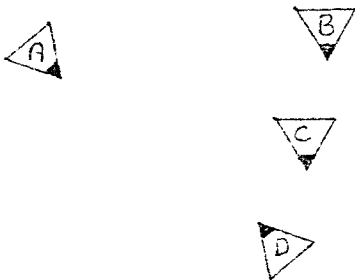

Audience

Audience

Deficiencies

---



---



---



---

Your Solutions

Audience

Audience

Q. A is speaking: others listen to A.

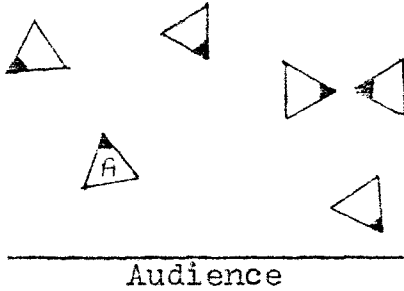

Deficiencies

---



---



---



---

Your Solutions

Audience

R. A is addressing a crowd and is giving an impassioned speech.

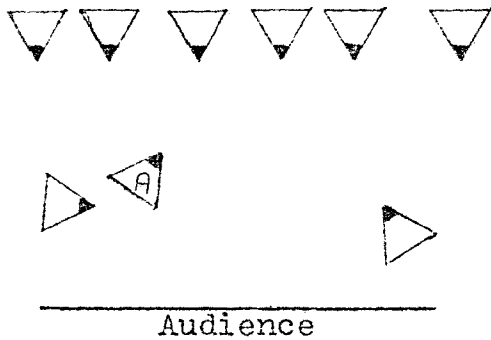

Audience

Deficiencies

---



---



---



---

Your Solutions

Audience

Audience

S. A, B and C share scene; the others listen to them.

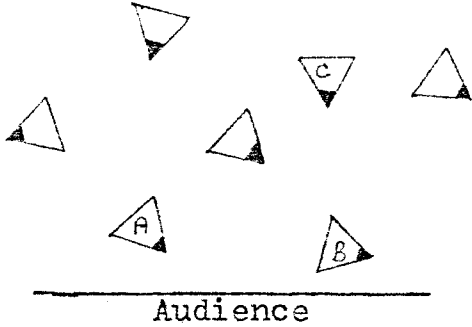

Deficiencies

---



---



---



---

Your Solutions

Audience

T. A addresses a group.

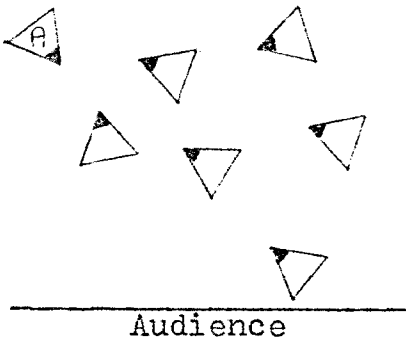

Audience

Deficiencies

---



---



---



---

Your Solutions

Audience

Audience

U. C is giving climactic speech of the play (Keep same items of furniture). Everyone is seated.

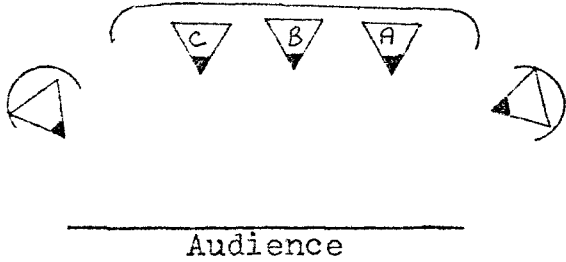

Deficiencies

---



---



---



---

Your Solutions

Audience

V. B and F are arguing; A, C and D are B's followers. E and G are F's followers.

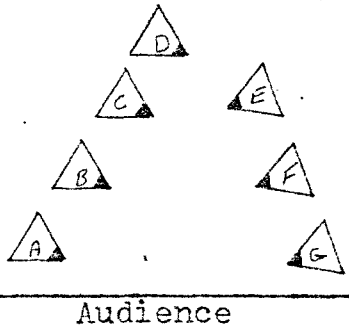

Audience

Deficiencies

---



---



---



---

Your Solutions

Audience

Audience

W. B, the king, is giving a speech to his subjects.

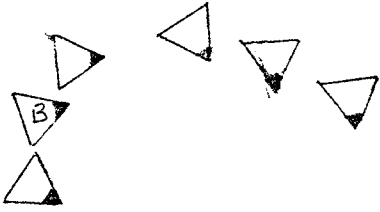

Audience

Deficiencies

---

---

---

---

Your Solutions

Audience

Audience

X. A and D are having a discussion; the others are members of their family listening to discussion.

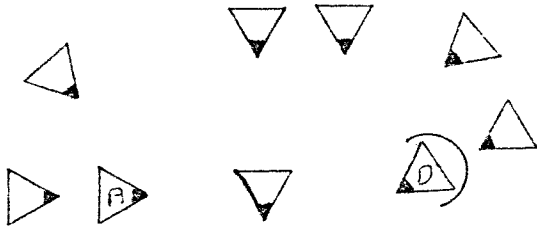

Audience

Deficiencies

---

---

---

---

Your Solutions

Audience

Audience



## CHAPTER IV

### DESIGNING THE GROUNDPLAN

#### THE INFLUENCE OF THE GROUNDPLAN

A director can do no accurate blocking at all until he has collaborated with the designer to bring into being a groundplan, drawn to scale, that will show the dimensions of every element of the setting, the location of the entrances, the heights of the platforms, or steps, and a tentative siting of the furniture.<sup>1</sup>

Aware of the necessity of a well-conceived groundplan, master directors, regardless of their philosophy or approach to directing, habitually devoted much care and attention to its design. David Belasco, best known for his naturalistic extravaganzas, would meet with his designer,

take the empty stage and, as far as possible, try to act the whole play, making every entrance and exit and indicating ideas of the groupings of the characters and their surroundings. This process . . . would consume perhaps four or five evenings, for not one detail could be . . . put aside until [Belasco] was satisfied that it could not be improved.<sup>2</sup>

---

<sup>1</sup>Canfield, p. 130.

<sup>2</sup>Toby Cole and Helen Krich Chinoy, Directors on Directing (Indianapolis: The Bobbs-Merrill Company, 1963), p. 126.

Likewise, Vsevolod Meyerhold, the Russian avant-garde director of the early twentieth century, writes:

Before deciding . . . on a satisfactory Mise-en-scene, we experimented with a number of variants. One variant, later rejected but worth mentioning, consisted of dividing the stage . . . into three planes: the proscenium, plus two further levels, respectively one and two steps higher than the proscenium; both levels were narrow, like pavements stretching the width of the stage and parallel to the proscenium opening. Each level had its own particular role in the action.<sup>3</sup>

Although of significantly different "schools" of directing, both men indicate--(Belasco through the amount of time spent and his attention to detail and Meyerhold through his repeated trial-and-error experimentation)--the importance of the design of the groundplan. Each realized that he was, in fact, pre-setting the whole tone of the production.<sup>4</sup>

The ability to design a groundplan is essential to the director, for through the selection and arrangement of the set pieces he creates the working environment for the actor, determining not only the actor's relationship to his surroundings, but also to the other actors.<sup>5</sup>

---

<sup>3</sup>Meyerhold on Theatre, ed. Edward Braun (New York: Hill and Wang, 1969), p. 145.

<sup>4</sup>Esme Crampton, A Handbook of the Theatre (Canada: W. J. Gage, 1964), p. 129.

<sup>5</sup>Cole and Chinoy, p. 28.

In the aforementioned production of Hedda Gabler, the director conceived of Hedda as a trapped animal, desperately trying to escape her surroundings, and visualized her environment as a "cage" (this metaphor will be discussed more fully in Chapter V). Consequently, the groundplan needed to reflect the basic qualities of a cage--four strong walls with no visible means of escape. To achieve this effect, furniture was placed on the proscenium line and the fourth wall was indicated by jogs which projected several inches onstage at the proscenium line; any hint of the outdoors was eliminated by covering the windows and double doors with heavy drapery and the use of dark masking flats behind the major entrances; furniture was arranged, with the sitting areas center stage and tables, desks, etc. (non-sitting areas) on the periphery, to provide Hedda with an unbroken, unending circular movement pattern around the outside of the room; and the sitting areas which did exist were made "uncomfortable" for Hedda by placing Tesman's book, papers and other belongings on them.

The groundplan for Hedda Gabler is illustrated in Figure 1.

Figure 1: Groundplan for Hedda Gabler

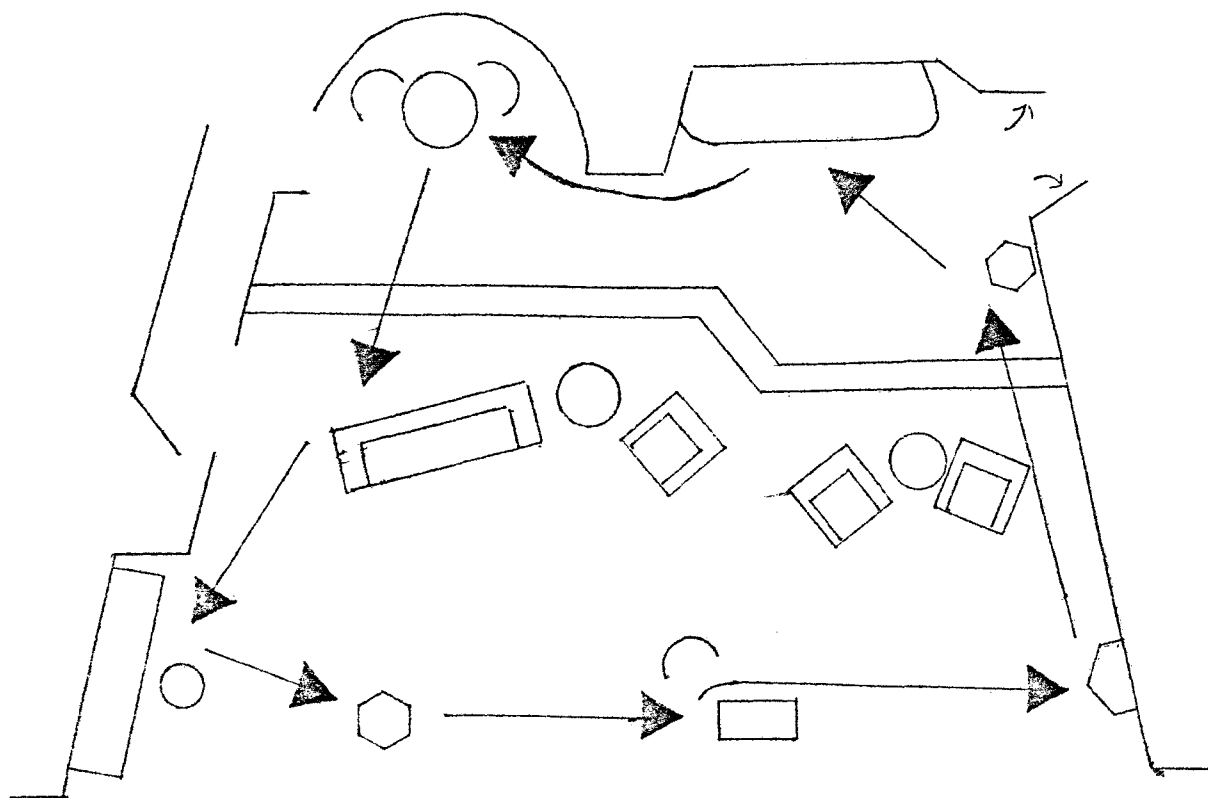

Placed in this environment during an improvisation in which she was directed to escape, the actress portraying Hedda moved frantically around the perimeter of the room, unable to either escape or to rest more than momentarily because all of the seats were "owned" by Tesman. During this improvisation, she gave the appearance of being extremely anxious, driven by a mysterious inner force, and hence a critical aspect of Hedda's psyche had been visually realized. (This movement has been indicated by the lines and arrows in Figure 1.) The insight gained

into Hedda's emotional constitution and the manifestations of her inner nature through the movement developed by this improvisation served as the basis upon which the scene described in Chapter V was built.

Although the importance of the groundplan can be easily overlooked when it is well designed and creates a working environment which assists the actors, the director who is forced to work with a poorly conceived floorplan quickly rediscovers its importance. The following figures illustrate groundplans from an actual production which hindered rather than facilitated blocking.<sup>6</sup>

Figure 2: Groundplan for Arms and the Man, Act II

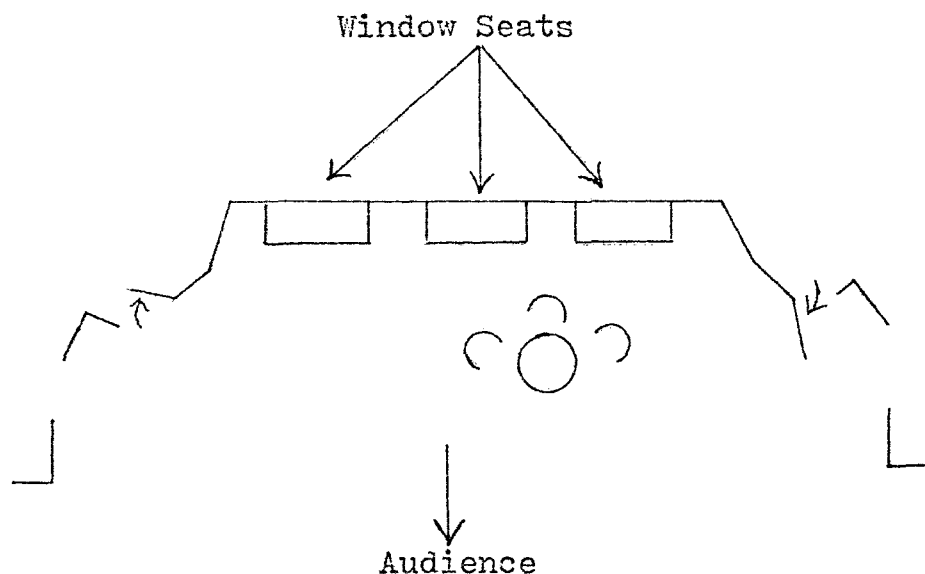

---

<sup>6</sup> Arms and the Man, presented by the University of Montana Department of Drama, May, 1973, Robert Ingham, Director, Peter Maslan, Designer.

Figure 3: Groundplan for Arms and the Man, Act III

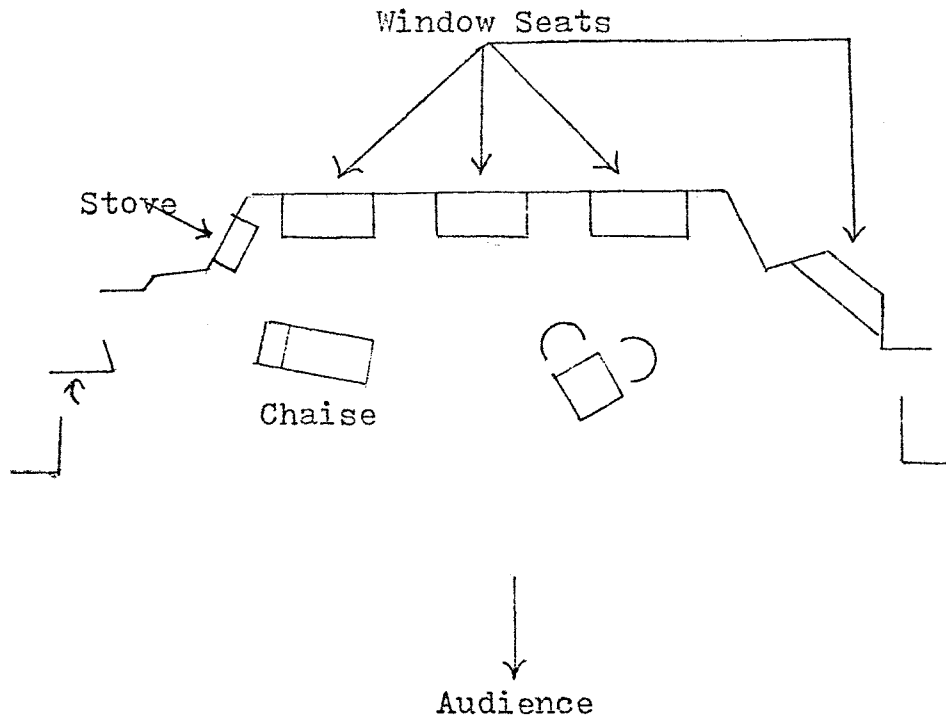

Blocking on these sets was forced essentially into three planes which were parallel to the proscenium line. Diagonal planes were virtually non-existent in the floorplans for both acts and the general lack of set pieces in Act II resulted in an absence of variety in blocking which became apparent near the end of the act. In describing such sets and the blocking problems which they create, Mordecai Gorelik states,

The setting is basically that of a rectangular box with the long wall parallel to the footlights. Such a plan, often symmetrical as well,

tends to be static and unrelated to the movements of the actors.<sup>7</sup>

Since the entire production in this case was adversely affected by poor design of the groundplan, hopefully the student will benefit by studying the problems in order to avoid them in his own productions.

---

<sup>7</sup>Mordecai Gorelik, New Theatres for Old (New York: E. P. Dutton and Company, 1962), p. 170.

## INSTRUCTIONS

Each of the following groundplans will, in some way, create problems for actors. Discuss the deficiencies of each and then, in your own drawing, improve the groundplan until it is usable. You may change the general shape of the set, the number and/or location of the entrances, add or subtract furniture or set pieces (including platforms), or change their size or shape. Before, however, you attempt to discuss or correct a groundplan, you should first determine how actors would move or inter-relate on the set. (The use of chessmen on a scaled model of the set is a convenient way of testing the groundplan.) Your preliminary drawings of the improved set may be free hand, but your final draft must be drawn to scale, for it is impossible to gain an accurate idea of the proportion of critical relationships on stage, the number of actors which can occupy a certain area on stage or the amount of space between set pieces in an unscaled rendering.



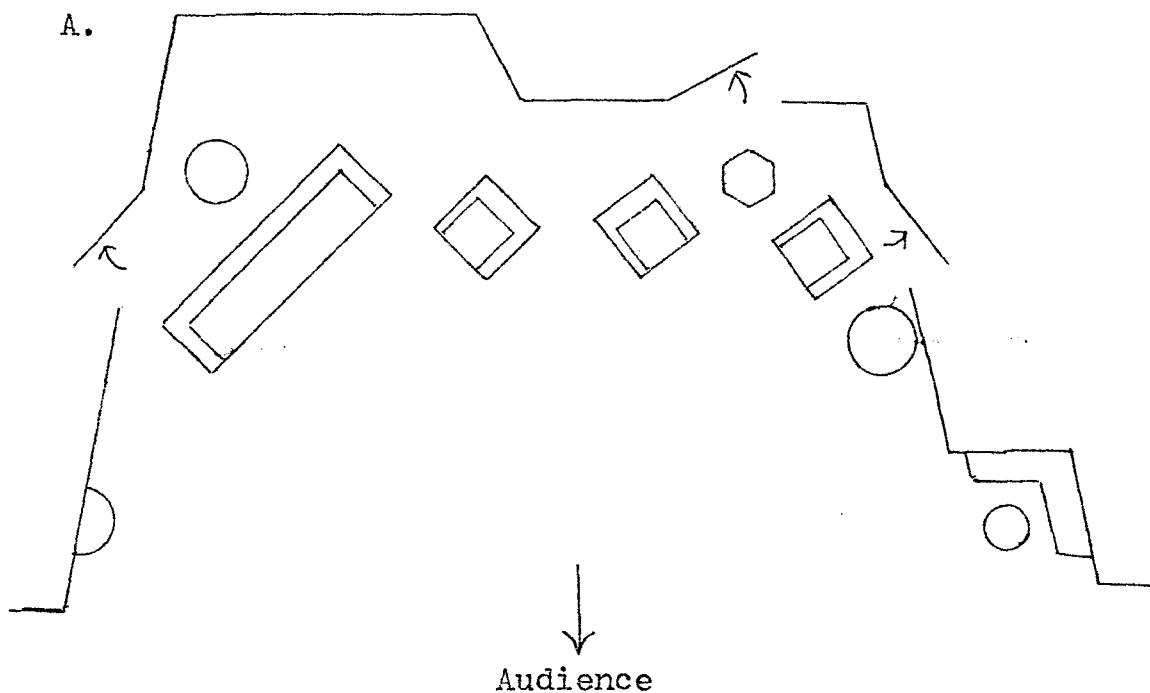

How would characters move on this set, starting with their first entrance?

Deficiencies:

Your Solution:

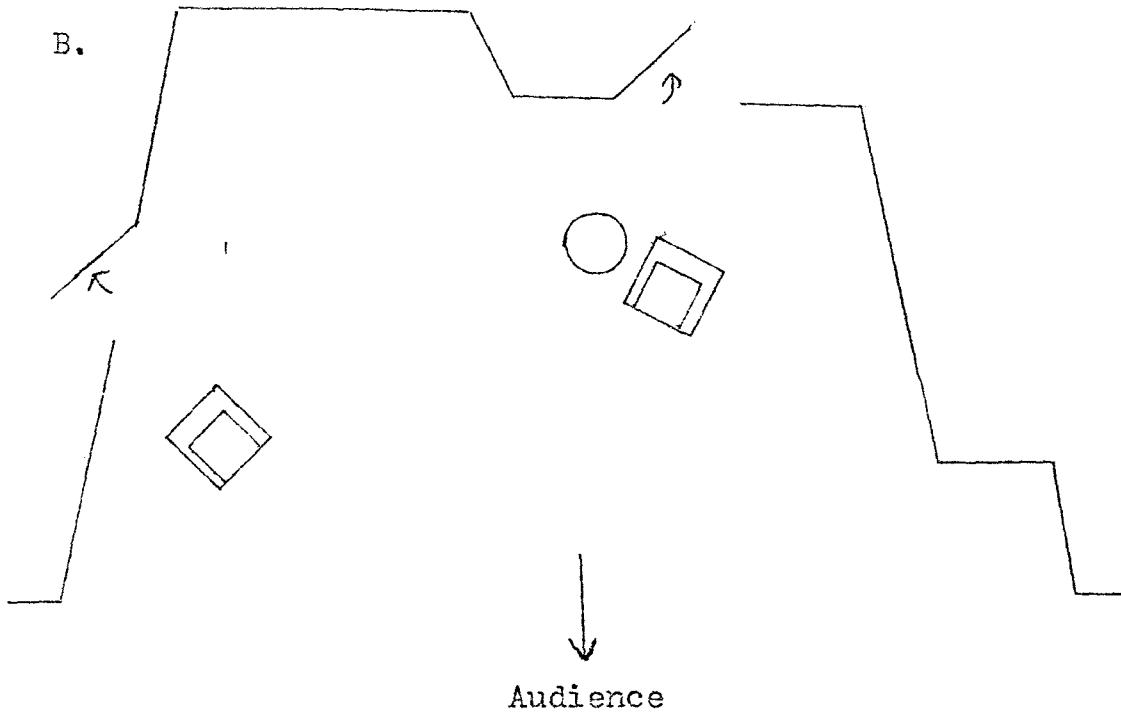

Deficiencies:

Your Solution:

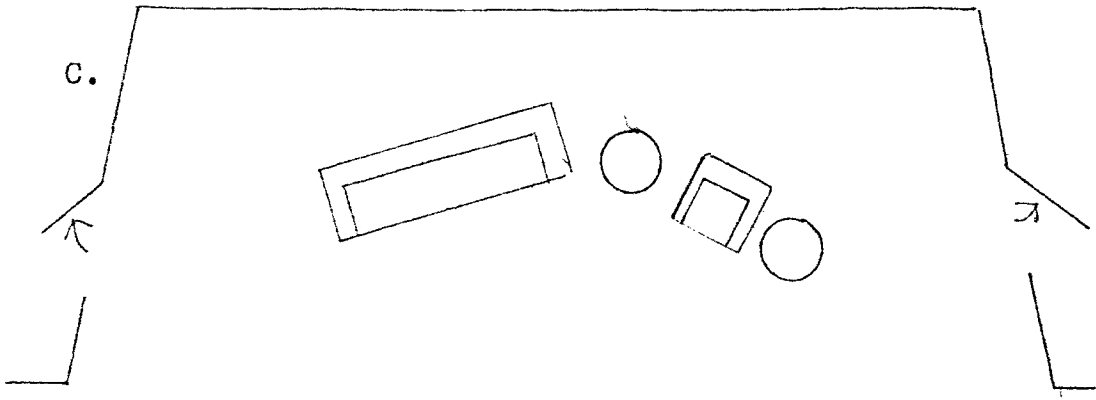

↓  
Audience

Deficiencies:

Your Solution:

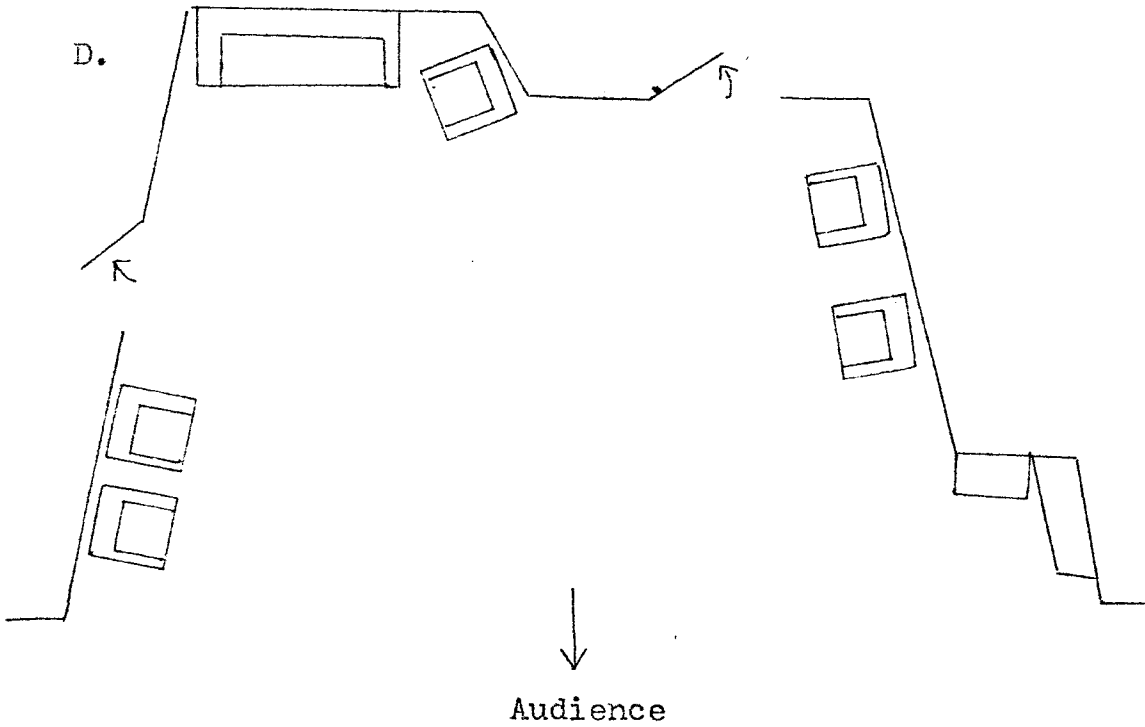

How would characters (3 to 5) move and inter-relate, using the furniture? Can you conceive of a situation in which this groundplan might be useful to you as a director?

Deficiencies:

Your Solution:

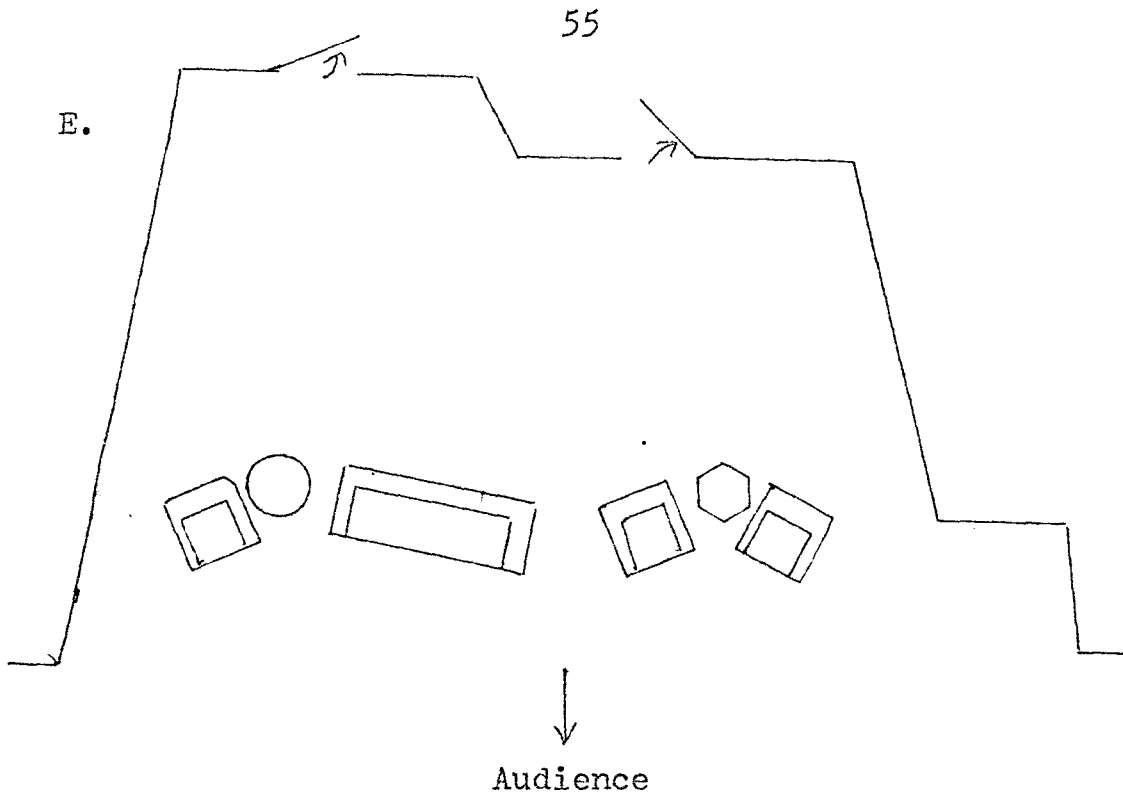

What happens to movement on this set?

Deficiencies:

Your Solution:

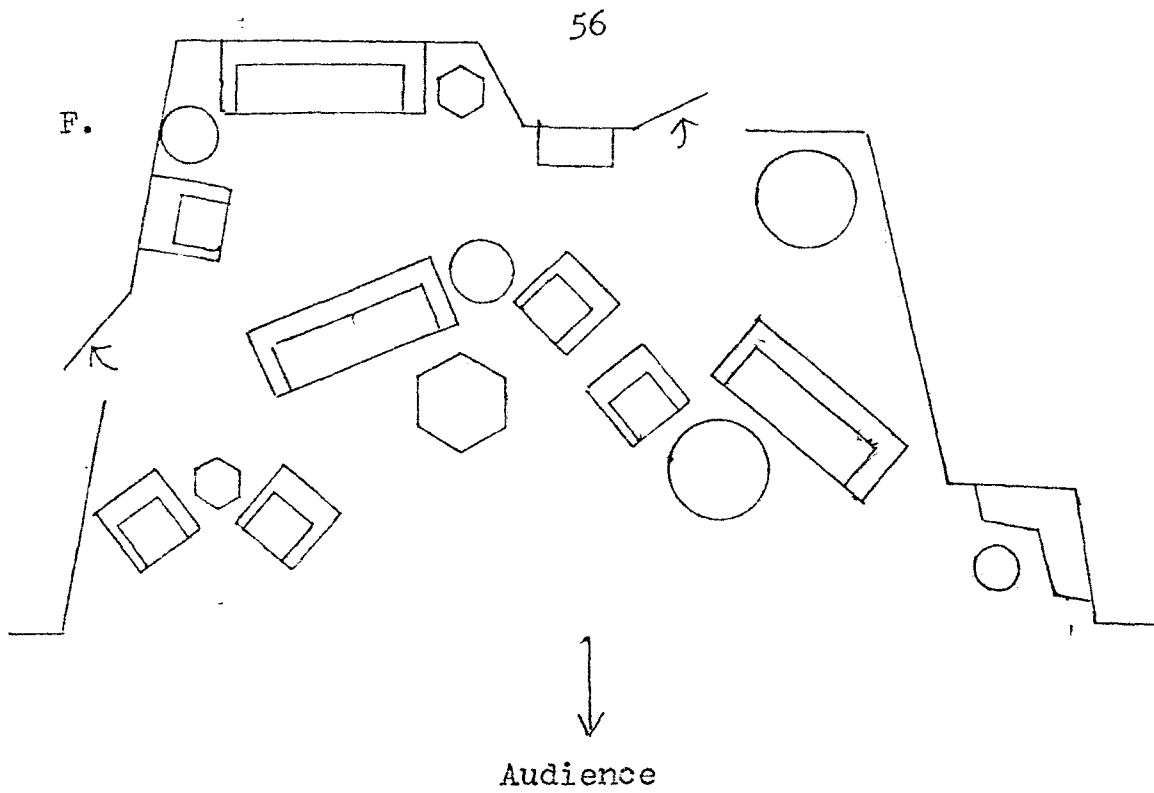

What happens to movement on this set?

Deficiencies:

Your Solution:

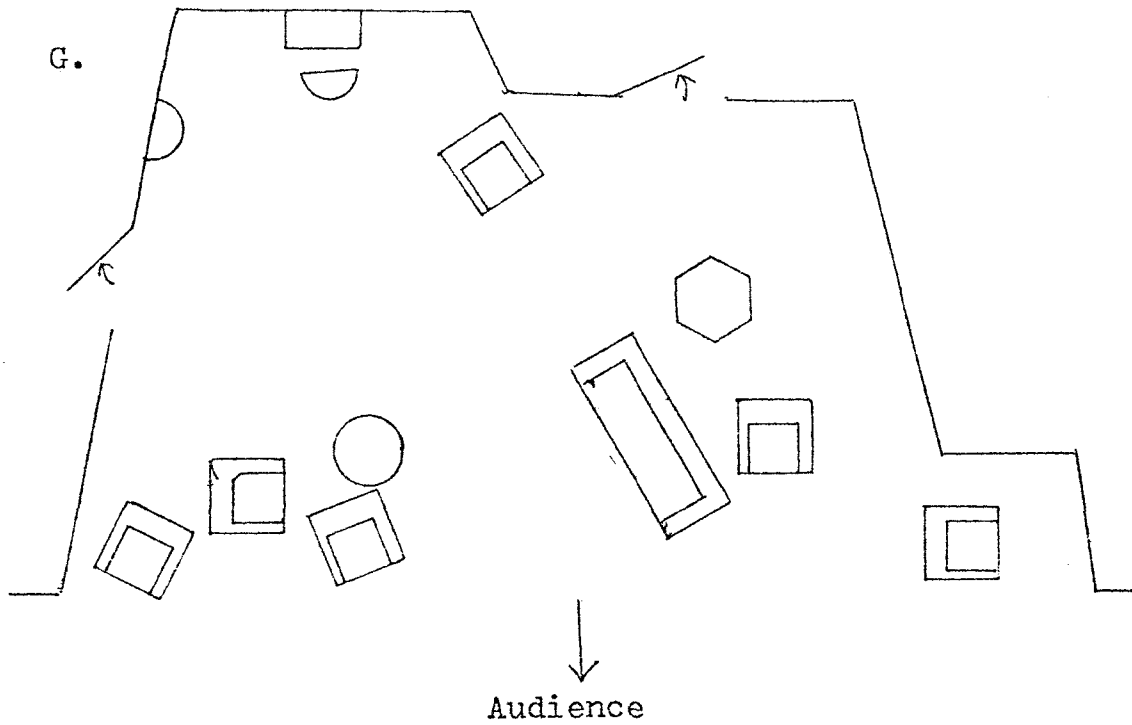

How would actors use the furniture to help them relate to each other?

Deficiencies:

Your Solution:

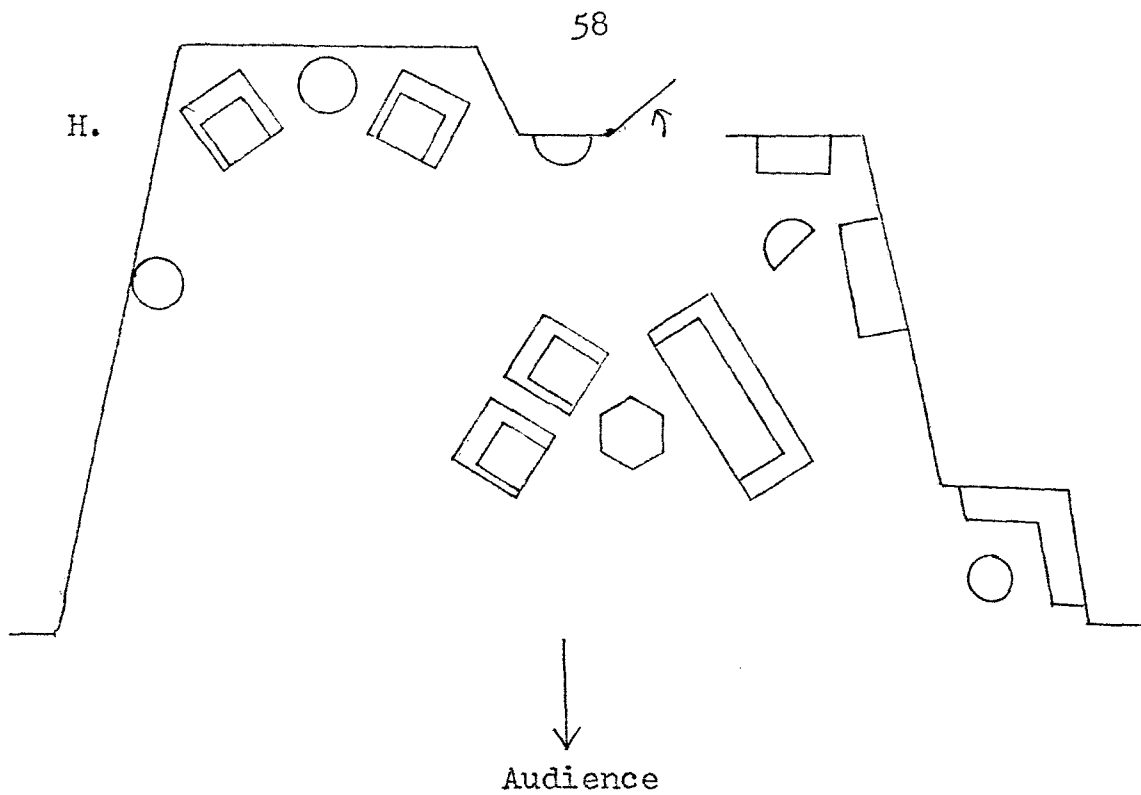

In which areas would most of the action of the play most likely take place?

Deficiencies:

Your Solution:



59

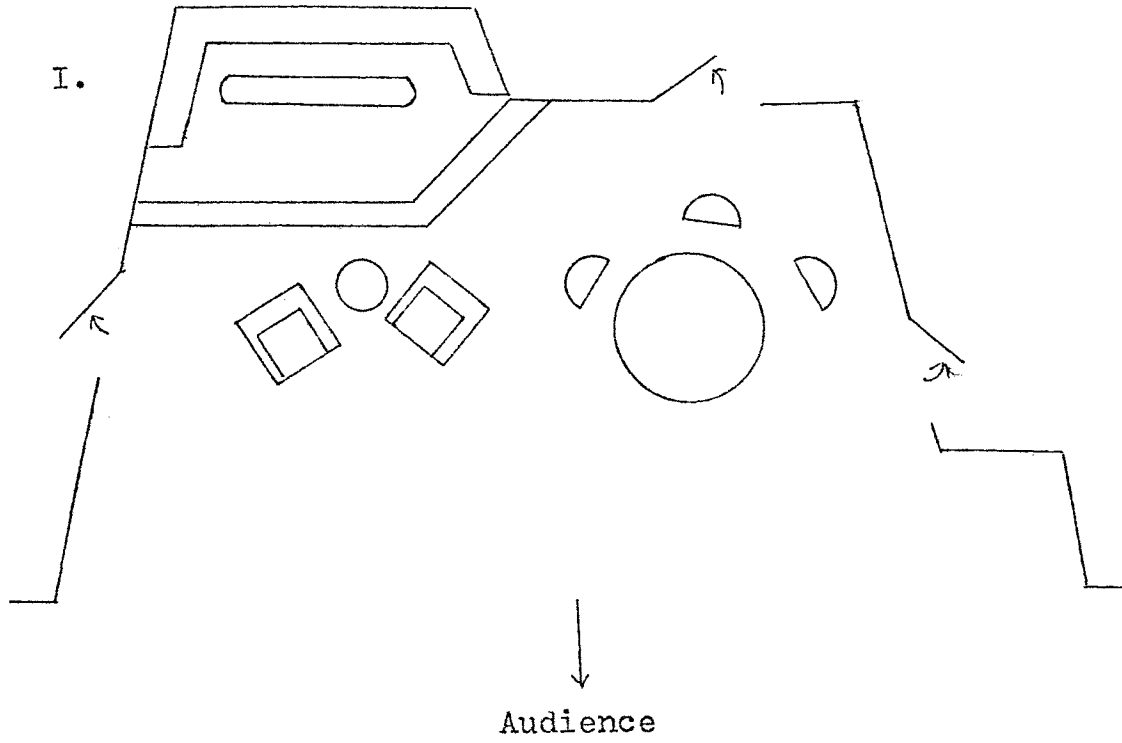

Deficiencies:

Your Solution:

## CHAPTER V

### MOVEMENT AND PICTURIZATION

#### INTRODUCTION

Stage movement has been described by one teacher-director as

the actual transit of an actor from one point on the stage to another. When a point is reached, the actor stands still and we have composition. Movement is therefore that which takes place between compositions.<sup>1</sup>

Movement according to this definition is therefore simply the technical means of changing the composition and achieving visual variety.

But is that all movement does? Other teacher-directors would argue that movement does much more.

Movement, like static inter-relationships, has its human meaning as well as its theatrical meaning and it must first serve the human needs, and then satisfy the necessity of getting the actor from point to point on the stage for reasons of emphasis, composition or pictorial symbolism . . .<sup>2</sup>

Movement has meaning because people in real life do not simply move for the sake of moving, but rather move because something motivates them--a physical stimulus, an

---

<sup>1</sup>Hodge, pp. 135-136.

<sup>2</sup>Cameron and Hoffman, p. 311.

idea or an emotion.<sup>3</sup> The movement is therefore fulfilling a human need or desire and is a response to an inner drive or motivation. Therefore,

Movement can convey illustrations to an audience quickly and with force. An actor walking conveys a very different idea from an actor running or sauntering; and walking toward an actor means something very different from walking away from him.<sup>4</sup>

The descriptive power of movement is so strong that when the text and the movement of a scene contradict each other, the audience will believe what it sees, not what it hears.<sup>5</sup> This partially explains why, for example, an audience often sees a character exhibiting weakness or vacillation even when the lines he delivers are strong or decisive. If the character is speaking forcefully to or threatening another character, but is backing away from him, his movement belies his speech regardless of how convincing his delivery. Thus, movement is not simply a technical means of changing composition, but when used symbolically becomes one of the most powerful tools for communicating a play's meaning.

Picturization is the addition of meaning to the abstract patterns of composition by determining "each

---

<sup>3</sup>Marian Gallaway, The Director in the Theatre (New York: The Macmillan Company, 1963), p. 169.

<sup>4</sup>Hodge, p. 136.

<sup>5</sup>Cameron and Hoffman, p. 311.

character's stage tasks and resultant postures, gestures, body positions, spatial relationship to each other."<sup>6</sup>

It is essentially "a succession of still shots . . . containing detailed story telling elements."<sup>7</sup>

Literal interpretation of this definition, however, will lead to the wooden effect achieved by the third rate photographer who poses his subjects too carefully. To avoid this effect in your own blocking, you must allow the stage pictures to develop naturally from the overall flow of the movement of the scene. As you visualize characters moving in a given scene, certain pictures will strike you as especially descriptive and you may choose to record them in the director's book, using stick figures or actual drawings of the characters.

In actual use, these pictures excerpted from the flow of movement and recorded on paper will remind you of your original conception of the scene. Under no condition, however, should you show your drawings to the actors or force them to re-create exactly what has been drawn. Setting the actor's every move is the prime cause of stiff, wooden, unnatural stage pictures.<sup>8</sup>

---

<sup>6</sup>Frank McMullan, The Director's Handbook, (Hamden, Conn.: The Shoestring Press, 1964), pp. 40-42.

<sup>7</sup>Hodge, p. 127.

<sup>8</sup>Galloway, p. 176.

## SECTION 1: BLOCKING A SIMPLE STORY

Instructions

In this section of the workbook, you will be given a basic situation or story with a central theme and then four variations of the story. Each variation will be considered a separate scene and will require different blocking to reveal its content. Your preparation of each scene should contain:

(1) A written analysis including the central idea of the scene (theme), each character's motivation or spine, and a description of the action of the scene. This step should not be ignored because your blocking will depend entirely upon your mental image of the scene.

(2) Several compositions, each with one character dominant. The compositions should be balanced and unified and the blocking of the entire scene should show variety.

(3) An indication of the shape, speed and direction of all of the movement in the scene, using arrows.

(4) Drawings, using stick figures, of the important stage pictures in the scene. There should be at least one stage picture for each composition.

(5) Notes (on the side of the page, below the compositions, or on a separate piece of paper), detailing important business, gestures, movements not included already or other details which you, as director, feel are important.

(6) A list of any shorthand or symbols used in your blocking. For your future reference, you may record these on the blank page provided at the end of this chapter.

Example

This example is based on the scene in Hedda Gabler in which Thea enters Hedda's home for the first time. The basic story is: Woman H (Hedda) wants information from T (Thea). T is afraid of H and reluctant to speak to her. The central dramatic action of the story is the struggle for the information which T possesses. H, sensing that T is ill at ease when she enters, tries to win her trust and confidence. H leads T to the sofa, sits beside her, and tries to get her to relax. T, however, is threatened by H's proximity and withdraws even further. H, sensing this, rises from the sofa and moves away from her hoping that with the physical threat removed, T will speak. The plan works and T, feeling that H wishes her no harm, begins to speak. As she speaks, her confidence slowly returns and H, realizing this, returns to the sofa to begin her probings for the desired information.

H's motivation in the scene is to extract the information from T at all costs. When one plan fails, she tries another. T, shy and untrusting, desires to maintain her privacy and to prevent H from harming her in any way.

The blocking of this simple story might appear in a director's book as follows:

(1) T enters right door, stops and waits for H to notice her. H, sitting left on sofa, notices T, puts down the book she is reading, and crosses to her.

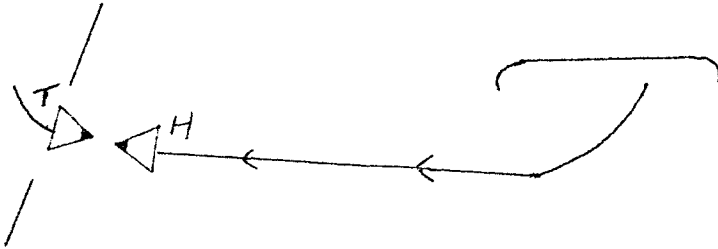

(2) H gently leads T by the hand across the room to the sofa. She seats T center on sofa and then sits left of her and facing her to begin her probing.

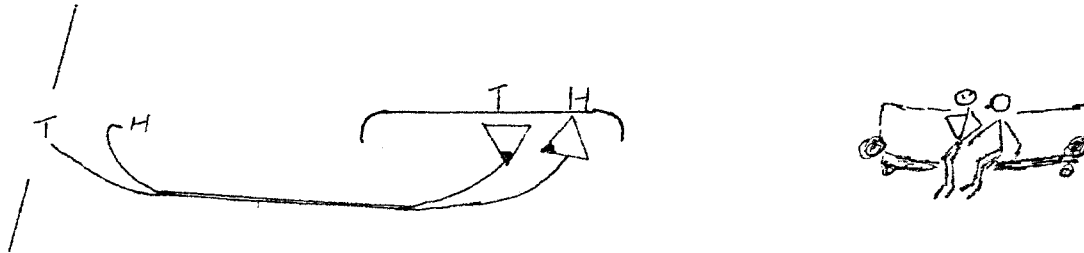

(3) T, feeling threatened, moves to extreme right on sofa and turns back on H. H moves to center of sofa and reaches out to T to comfort her.



(4) Sensing that T is threatened by her, H rises and crosses left, speaking with her back to T. Eventually she turns to face her.

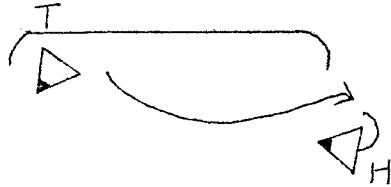

(5) T, no longer threatened, turns to face H. As she gains confidence, she leans forward on her left arm to speak to H and moves to center of sofa.



(6) Sensing T's new-found confidence, A decides to test her and approaches the sofa, keeping it between her and T.

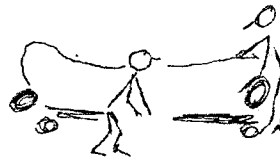
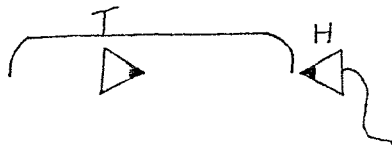



(7) When T shows no alarm at her approach, H moves to sit next to her on the sofa. They carry on an uninhibited conversation and H gets the information she desires.



In solving the problems in this section, you are asked to follow the same procedure, beginning with a written interpretation of the story and then translating it into symbols which will later serve as the basis of the blocking rehearsal. Although you are without a playwright's description of a character to guide you, each simple story can nevertheless be effectively blocked. You, the director, must ask yourself: How would people behave in this situation? What would they do? How would they relate to other people given the basic situation in which they find themselves?

Problem 1

Utilizing the guidelines of composition, movement and picturization block the following scenes involving two characters. Remember that in each stage picture one character is dominant. Two or three pieces of furniture may be added.

A. A man is dictating a letter to his secretary . . .

1. in a "normal" business relationship.

2. they are in love with each other, but make no attempt to conceal the fact from others in the office.



- B. (For this problem, the characters should remain seated.)

Two men are discussing business over lunch in a restaurant . . .

1. they are rivals in business and do not trust each other.

2. they are involved in a criminal transaction which is about to be discovered.

3. they are involved in a real estate transfer as a part of their normal business routine. They are good friends.

4. the "business" is the fact that one man is accusing the other of having an affair with his wife.

C. Two people meet on a city street . . .

1. they are old friends who have not seen each other for years.

2. one suspects the other of picking his pocket.

3. one tries to borrow money from the other.

4. they are old friends who have not seen each other for years, but are not sure that the other is his old friend. Each might be saying, "I could swear that's . . ."





3. the item is stolen.

4. the salesman is insulting and abrupt with the customer.



3. the detectives have very little interest in the suspect. (You may determine your own reasons. Be creative.)

4. the suspect refuses to answer the questions.

B. A father and mother are saying good-bye . . .

1. to a son who is going off to war.

2. to an unwelcome relative.

3. to their son whom they have ordered to leave the house forever.

4. to their only daughter who is going out on her first date.

C. Two men try to stop another from entering a room . . .

1. they are guards acting in an official capacity and the man agrees to leave.

2. they are guards acting in an official capacity but the man tries to force his way in.

3. the men have no official capacity and are trying to protect something in the room from being discovered.

4. the man trying to enter is a V.I.P. and the two men are guards.

D. Three men enter a building . . .

1. they are trying to sneak in undetected.

2. they are trying to make a good impression and make themselves noticed.



3. they are in a hurry to enter, but the door is locked.

4. they are eager to enter, but are unsure of being at the correct address.

## MOVEMENT PATTERNS

Instructions

Early in Act I of Hedda Gabler, Ibsen reveals a great deal about Hedda by having her simply move about the room alone. He describes these movements in the stage directions which precede the scene:

Hedda paces about the room, raises her arms and clenches her hands as though as in desperation. She flings back the curtains of the glass door and gazes out.<sup>9</sup>

Needless to say, Ibsen has provided a magnificent opportunity for the actress (and the director) to use the descriptive power of movement; but how is this movement to be shaped, what is the tempo of the movement, what props or set pieces are to be handled, and how are they to be handled? These are all questions which the director must answer, for while Ibsen's intent is clear, the exact movement is not specified.

The following is a hypothetical director's concept of the scene:

---

<sup>9</sup>Six Plays by Henrik Ibsen, trans. Eva LeGallienne (New York: Modern Library, 1957), p. 354.

I see Hedda as a wild animal, caged against her will, straining at the bonds which hold her, constantly examining her prison with the hope of finding some means, any means, of escape. When people are present, she toys with them playfully, suddenly strikes out viciously at them, and then just as suddenly retreats, skulking off to some distant corner of the room. Left alone (as she is in this scene), she silently watches her captor leave the room, then aimlessly wanders to a small table between the chairs stage left where she amuses herself by pushing a stack of papers around, finally knocking them onto the floor. Pleased with herself for a second, she leaves the table and moves slowly center where she is suddenly seized by a new feeling, a powerful feeling. Trying to escape it, she nervously paces back and forth (a distance of not more than six feet), wheeling like a tigress at the end of each transit. Suddenly her eye catches a document on the mantle which arouses her curiosity (it is Tesman's degree in a frame), but before she reaches the mantle, out of the corner of her eye, she spots George's books on the desk. She knocks them off the desk and across the room. Frantic now, she races to the door leading to the hallway, stops, wheels and races to the door to the garden. Reaching the door, she flings it open and is bathed in sunlight. Somehow this relaxes her and, for a moment, the beast is soothed.

Figure 1 is a diagram (with annotation) of the movement in this scene.

Figure 1: A Descriptive Movement Pattern in Hedda Gabler

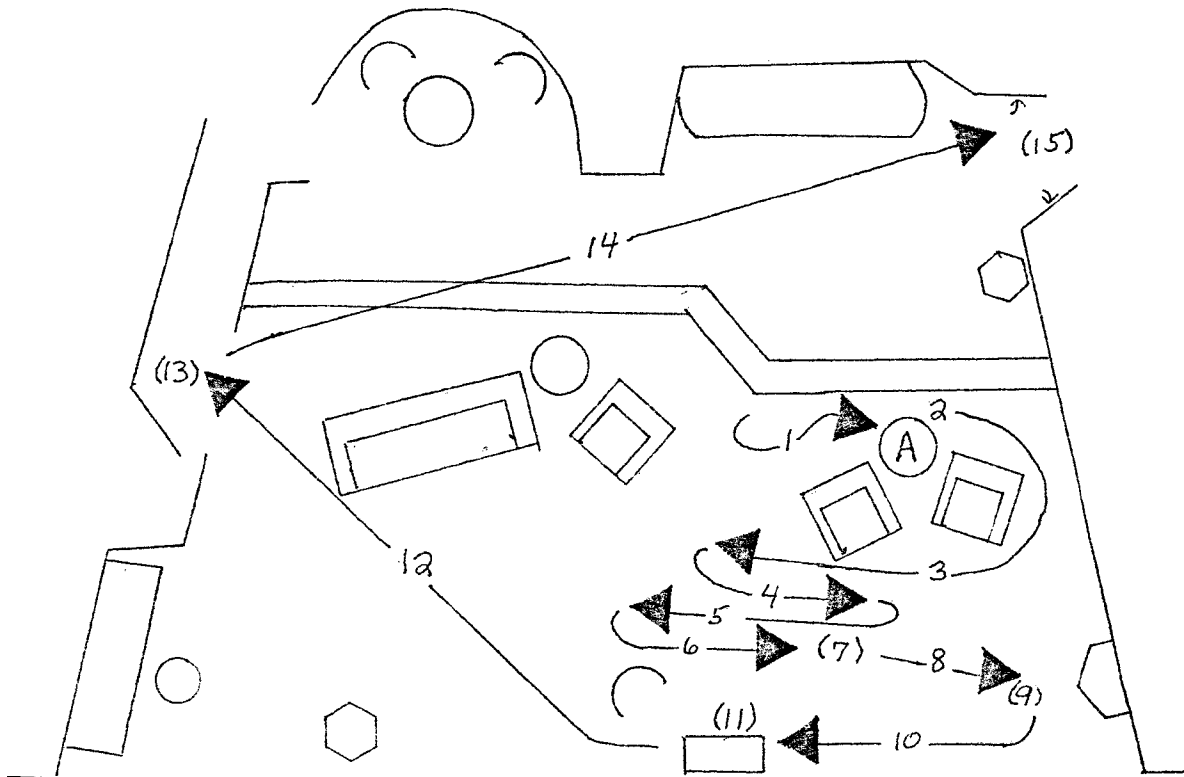

1. Hedda moves slowly to the table (A).
2. Shuffles papers on table and finally pushes them onto the floor.
3. Crosses DS left of chair and to center.
- 4.-6. Nervously paces center stage, wheeling rapidly at the end of each transit.
7. Pauses, sees diploma on stove, is curious.
8. Is slowly drawn to mantle, studies diploma.
9. Sees books on desk and pauses momentarily.
10. Violently charges the stack of books.
11. Knocks books onto floor.
12. Out of control, she rapidly crosses to door leading to hallway (DS sofa), kicking books as she goes.
13. Pauses, makes decision.
14. Races (US sofa) to double doors UL.
15. Flings open both doors and stands looking out into garden.

For the following scenes, each involving a single character, an overall movement pattern should be composed based upon how you visualize the character moving about the set. You should include what props or set pieces they would touch, how they would handle them and the speed at which they would move. As in the previous exercises on movement and picturization, you should prepare a written analysis of the scene.

Record all symbols and abbreviations you intend to use on page 91.

Since this is primarily an exercise in movement patterns, groundplans have been provided for you. If, however, you are unable to block the scene using the groundplan provided, you may revise it or design your own groundplan.

Problem 1

The final scene in Act IV of The Cherry Orchard by Anton Chekov in which Firs is left alone in the deserted house.

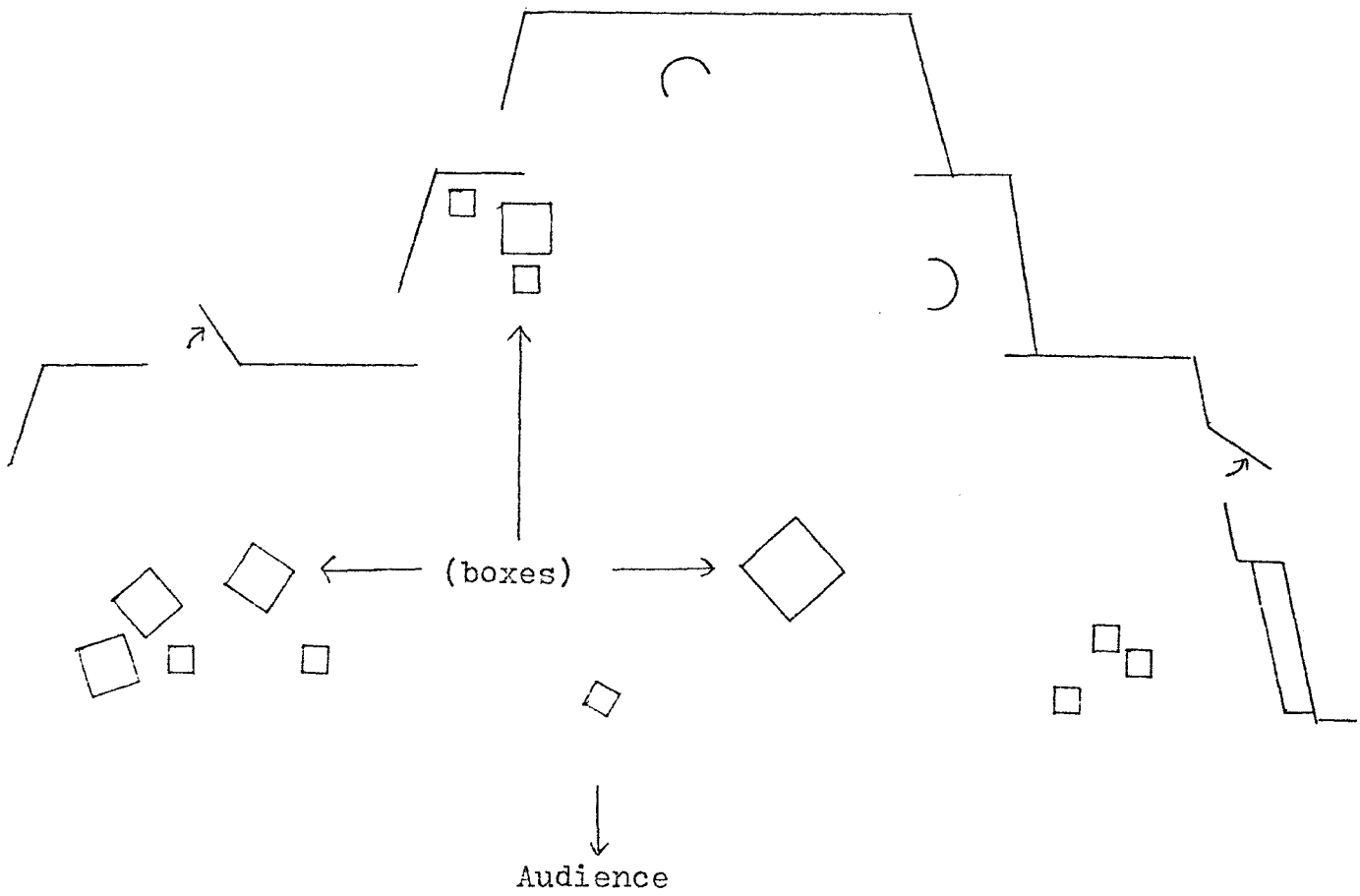

Problem 2

Hedda's burning of Lovborg's manuscript at the end of Act III of Hedda Gabler.

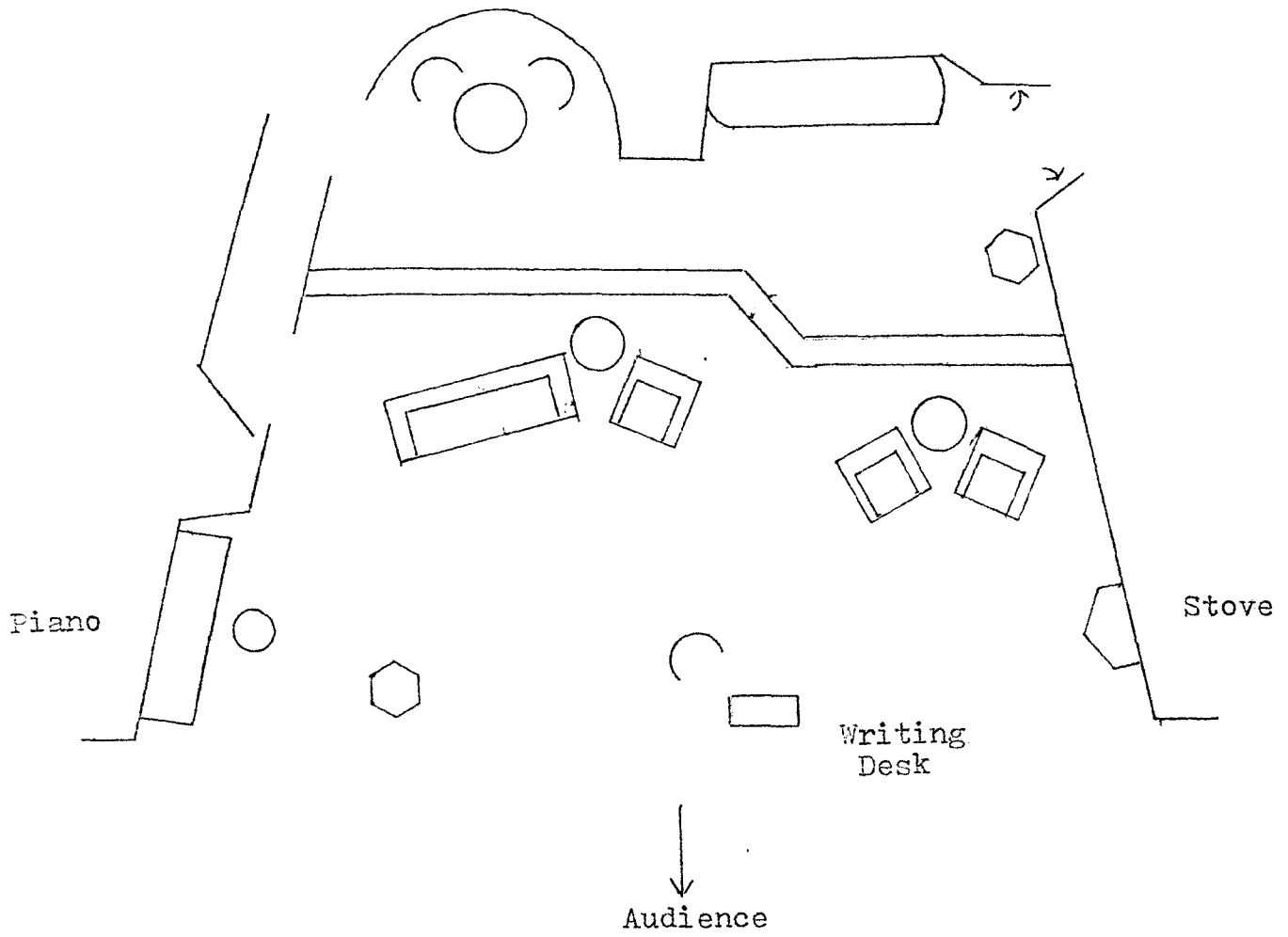

Problem 3

Tom's monologue at the beginning of Act I  
of The Glass Menagerie by Tennessee Williams.

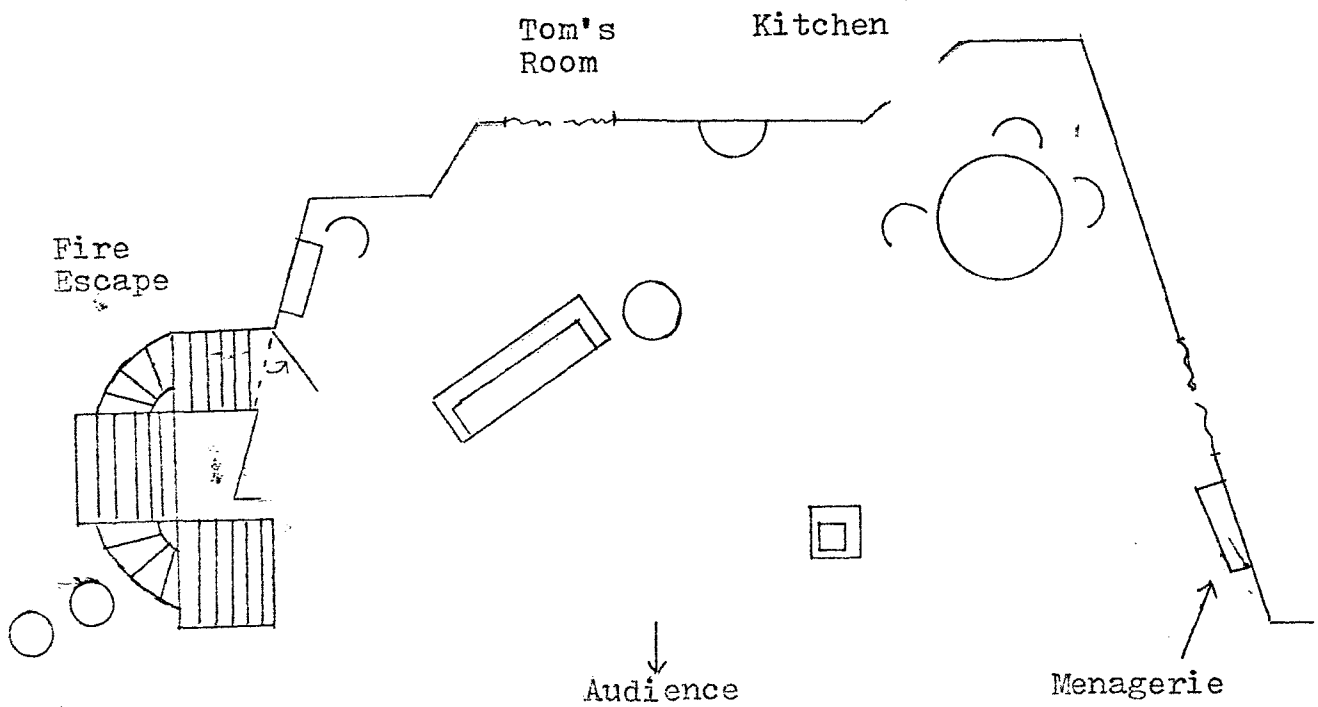



Director's Shorthand

Abbreviations or symbols which you intend to use.

Cross \_\_\_\_\_

Sit \_\_\_\_\_

Stand \_\_\_\_\_

Counter-cross \_\_\_\_\_

Pause \_\_\_\_\_

Turn \_\_\_\_\_

\_\_\_\_\_

\_\_\_\_\_

\_\_\_\_\_

## CHAPTER VI

### THE USE OF BLOCKING AS A DESCRIPTIVE TOOL

#### ANALYZING THE PLAY

The process of becoming acquainted with a play is like that of becoming acquainted with a person. It is an empirical and inductive process; it starts with observable facts; but it instinctively aims at a grasp of the life of the machine which is both deeper and, oddly enough, more immediate than the surface appearances offer.<sup>1</sup>

The process of gaining insight into another human being begins with a first impression, a "gut feeling" about that individual which is often expressed simply as, "I like him" or "I dislike that person." If the first impression, however, is favorable, it is likely that he may become an acquaintance or even a friend. In subsequent meetings the general impressions of the first meetings tend to become more specific in nature. His outward appearance--his approximate height and weight, the color of his hair and eyes, his physique, mode of dressing, the fairness or coarseness of his features, the way he moves and his mannerisms--are noticed and recorded. Meanwhile,

---

<sup>1</sup>Francis Fergusson, The Idea of Theater (Princeton, N.J.: Princeton University Press, 1949), p. 11.

the initial "gut reaction" is either revised or reinforced. As friendship grows, he gradually reveals the events of his past, his sense of values, his fears and desires, and through what he says and does, the inner workings of his mind. If the relationship continues to develop, it is even possible to gain insight into the very essence of his nature, his *raison d'etre*.<sup>2</sup>

The stage director, in much the same manner, develops an understanding of a play. If his initial impression is favorable, if his artistic enthusiasm and fervor are stirred, he will wish to produce the play and continue to delve into its mysteries. He will then begin the process of play analysis which Constantin Stanislavsky describes as a series of searches which

are made . . . in the width, length, and depth of a play and its roles, its separate portions, its component strata, all its planes beginning with the external, more obvious ones, and ending with the innermost, profoundest spiritual levels. For this purpose one must dissect a play and its roles. One must plumb its depths, layer by layer, get down to its essence, dismember it, examine each portion separately, and find the stimuli to creative ardor.<sup>3</sup>

---

<sup>2</sup>Constantin Stanislavsky, Creating a Role, Translated by Elizabeth Reynolds Hapgood, with a foreword by Robert Lewis (New York: Theatre Arts Books, 1961), p. 3.

<sup>3</sup>Ibid., p. 11.

Although Stanislavsky indicates there are six levels of analysis, he readily admits that some of them are of little importance to the director. In this workbook, therefore, several of his levels will be combined and studied under the following headings: the external or given circumstances; the internal level; and, the poetic or spiritual level.

#### The External or Given Circumstances

Fortunately for the stage director, the playwright in creating his work, weaves into the fabric of the text certain facts about the characters, the events of both the past and present, and the environment in which the characters live, which can be grasped consciously by the reader. Since these facts can be easily recognized and grasped consciously, they provide an ideal beginning point for the director. And since they often provide keys to the deeper, less conscious levels of the play, they become the foundation upon which the entire analytical process is built.<sup>4</sup> In analyzing Hedda Gabler, for example, the external fact that she was reared by a rigid military man in a home which was severely regimented leads both director and actor to Hedda's feelings about being confined

---

<sup>4</sup>Ibid., p. 13.

and ultimately to the metaphor of Hedda's being a caged animal. Ibsen, through the repeated references to the General and his description of the General's picture hanging in the prominent position on stage, has provided a tangible clue to the less tangible, but more essential elements of his play.

So important were the given circumstances to Stanislavsky that he habitually passed out extensive questionnaires for his actors to fill out and study. Included in one such questionnaire prepared for the participants in the ball scene in Griboyedov's Much Woe From Wisdom were such questions as:

What is your family's position in society? What was the 'flow' of your day like today? What were the good and bad incidents of the day? Whom did you see? What is your relationship to Famusov? How did you know of the ball? What is your outlook on the world?<sup>5</sup>

When asked why he spent so much time with such a small scene and demanded so much from "extras", Stanislavsky replied, "I want each actor, no matter how small his part, to create his life on stage on the basis of a complete knowledge of the life of the period."<sup>6</sup> The detailed biography was therefore a manifestation of his belief that

The line of analysis takes its point of departure

---

<sup>5</sup>Gorchakov, p. 148.

<sup>6</sup>Ibid, p. 149.

from the external form of the play, from the printed text of the playwright, which is accessible to our consciousness, and it goes from there to the inner spiritual essence of the play, that invisible something which the playwright put inside his work, and which is largely accessible only to our subconscious.<sup>7</sup>

The analysis of the given circumstances has been subdivided in the workbook into the following categories:

1. A summary of the major events of the plot.
2. A list of environmental factors--the social, political, economic and religious environment as well as specific time, location and climate.
3. A summary of the previous action: what has happened before the play begins.
4. A statement of the major characters' attitudes toward other characters and their environment.

#### The Internal Level of the Play

Once you have isolated and listed the given circumstances, their sequence and connection to one another, you must progress to the level of realities which lie beneath the surface of the written text. Often the first element of the "sub-text" to be uncovered is the dramatist's theme or central idea which may be simply expressed in one sentence--"this is a play about \_\_\_\_\_."<sup>8</sup>

---

<sup>7</sup>Stanislavsky, p. 12.

<sup>8</sup>Sievers, p. 57.

Laurence Olivier, for example, discussing the film version of Hamlet, expressed the theme of the play as, "A story of a man who could not make up his mind."<sup>9</sup>

Although this statement adequately describes the playwright's idea for the purpose of intellectual discussion, it has little dramatic value, it cannot be acted. Since the term, drama, is derived from the Greek verb, to do, the statement of the theme must be translated into more active terms and the essential dramatic action of the play identified. Oedipus Rex, for example, may be interpreted thematically as a play about the search for the murderer of a king, but in order to bring the play to life on the stage demands the statement of the playwright's idea as a histrionic action.<sup>10</sup>

Histrionic or dramatic action, however, should not be construed to mean simply an abundance of stage movement or gestures, but rather the internal, spiritual or emotional activity which serves as the impetus or motivation for external actions.<sup>11</sup> According to Stanislavsky, "External action when not . . . called forth by inner activity, is entertaining only for the eyes

---

<sup>9</sup>Laurence Olivier quoted in Sievers, p. 57.

<sup>10</sup>Fergusson, p. 35.

<sup>11</sup>Ibid., p. 230.

and ears; it does not penetrate the heart.<sup>12</sup> Thus, if the dramatic action of Oedipus Rex is hypothetically "to discover the truth at all costs," all outward signs of Oedipus' search for Laius' murderer must reflect his inner desire for the truth.<sup>13</sup>

While Oedipus directly fulfills the dramatic action of the play, the quest for the truth, the other characters serve as a "spectrum of action", showing numerous variations of the histrionic action. Jocasta consciously tries to prevent Oedipus from finding the truth; Creon unknowingly helps him by arousing his anger and determination; Teiresias and the herdsman, fearing for their lives, reluctantly reveal the truth; the messenger, thinking that he brings good news, joyously reveals the truth; and the chorus urges Oedipus on, in order to save themselves from the plague. Thus, all characters serve in the exposition and development of the central histrionic action.<sup>14</sup>

---

<sup>12</sup>Stanislavsky, p. 49.

<sup>13</sup>James H. Clay and Daniel Krempel, The Theatrical Image (McGraw-Hill Book Company, 1967), p. 104.

<sup>14</sup>Fergusson, p. 37.



The Poetic Level

The third and most elusive level of analysis entails envisioning the play in terms which appeal to a deep seated sensibility in humans and stir their imaginations. Whether this conceptual idea is called a symbol, a metaphor or a commanding image, you must grasp it, for it is

The essence of a playwright's communication. This essence, like the meaning of a dream, is a realization, a concept, a felt significance.<sup>15</sup>

Through an understanding and control of this "commanding image" you stir not only your audience, but your actors as well. In this case,

The importance of the image to the director is its value as a stimulant to creativity. It stirs the emotions as well as the mind, exhilarates, and encourages inspiration.<sup>16</sup>

The influence which an image can exert upon an actor preparing a role is best illustrated by example: in rehearsing Chekov's A Marriage Proposal for presentation in the Workshop for Theater in 1971, the actor portraying Chubokov was having extreme difficulty

---

<sup>15</sup>Clay, p. 25.

<sup>16</sup>Frank McMullan, The Directorial Image: The Play and the Director (Hamden, Conn.: The Shoe String Press, 1962), p. 11.

projecting the gruffness, the abruptness of his character.<sup>17</sup> Although he had "done his homework," knew the given circumstances of the play, his objectives, and the motivation for his actions late in the rehearsal period he was still unable to display the coarseness of his character. In an attempt to explain this quality so basic to his character, the director inadvertently seized upon this image and, with it in mind, his actions, his entire demeanor, became more gruff, more "bear-like". Thus, a vital aspect of his role had been visually realized.

In using a commanding image for a play or to assist an actor in preparing a role, you, however, must be careful to avoid employing the image literally. In the case cited, for example, the actor was not concerned with being a bear on stage, but with incorporating certain bear-like qualities into his portrayal of Chubokov. Likewise, a director who selected as the commanding image for Oedipus Rex "a searching movement toward a blinding light," must avoid directing Oedipus into making a series of obvious searching movements. This use of an image would lead to a didactic, or possibly even a ludicrous production.<sup>18</sup>

---

<sup>17</sup>A Marriage Proposal, presented at the University of Montana, August 1971, John Frick, Director, Allen Cook, Advisor.

<sup>18</sup>Clay, p. 106.

BLOCKING TO ILLUSTRATE THE  
PLAYWRIGHT'S IDEA

Although there is no standard means or formula for transforming the playwright's idea into visual patterns and movement, play analysis nevertheless may suggest an over-all pattern for the blocking. In staging Oedipus Rex at the Shakespeare Festival Theatre, Stratford, Ontario, Tyrone Guthrie proposed that the commanding image is "a searching movement toward a blinding light."<sup>19</sup> To illustrate this idea through his blocking, Guthrie adopted a method already used in films. As the searcher came closer to the truth, the camera would move closer to his face thus increasing the audience's intimacy and involvement with the protagonist. To adapt this technique to the stage, Guthrie envisioned the movement of the play taking place on a plane perpendicular to the proscenium arch with the scenes at the beginning of the play occurring upstage and the later scenes occurring further downstage. By bringing Oedipus

closer to the audience as the plot approaches its crisis, the audience would tend to feel a mounting tension . . . and the living presence of the

---

<sup>19</sup>Ibid.

suffering Oedipus would add to the impact of the device . . . The main psychological action of the play could be strengthened by this physical action.<sup>20</sup>

As an integral part of his over-all blocking of the play, Guthrie also wished to create an association between the altar located downstage center and the realization of the truth, with Oedipus' fate. He felt that once this association was fixed in the audience's mind, suspense could be created by moving Oedipus closer to the "fatal altar" as the plot progressed. To establish this association, Guthrie placed characters associated with the truth near the altar at the moment when they revealed the truth. Creon, when bringing the advice from the Oracle at Delphi, delivers his pronouncement while standing one step stage left of the altar. Likewise, Tieresias

enters, or seems to rise up, in front of the altar as he is led up the concealed steps just in front of the stage. Oedipus' respect and concern . . . motivate him to come down to meet the seer, and the agon is played far downstage, close to the fatal altar--for Tieresias, in his anger, brings Oedipus face to face with the truth.<sup>21</sup>

However, Oedipus refuses to realize the truth and his

---

<sup>20</sup>Ibid.

<sup>21</sup>Ibid., p. 110.

turning his back on the altar and walking away symbolize this.

With the seeds of the association sown, it is utilized to illustrate, not only Oedipus' approach to the truth, but Jocasta's as well. With Jocasta already located at the altar for her prayer scene, the Corinthian messenger arrives stage left. To listen to his message, Jocasta is forced to turn upstage, thus turning her back on both the altar and the audience. "At the moment when the truth hits her, she recoils and turns suddenly away from Oedipus to conceal her emotions from him and thus faces the audience again."<sup>22</sup> As she does so, she also faces the altar.

With the symbolism of the altar firmly established, Guthrie is prepared to stage the climactic scene. The old shepherd enters downstage left and in order to question him, Oedipus is forced to move toward the altar. As he begins to realize the full horror of the truth, however, he either turns away from the altar or stares over it into the audience, but returning to his quest, he is ultimately drawn to the exact point where Jocasta, Tiresias and Creon stood when embracing the truth. It

---

<sup>22</sup>Ibid., p. 111.

is here that the full impact of reality hits him and sends him screaming in terror into the house. When he re-enters, blinded, he is led once again to this very spot on the stage and the search for the blinding light has been completed.

Likewise, in the aforementioned production of Hedda Gabler, blocking was used to convey the idea that Hedda was a caged animal trying to escape her environment. Although overt animal actions, such as clawing at the walls, were avoided, her restlessness, her pacing and her constant circling of the room resembled that of a wild beast confined in a cage. By varying the tempo and intensity of this movement, the director could control somewhat the degree of her entrapment felt by the audience.

In your work you likewise must try to predict what effect your blocking will have upon an audience, but must avoid a literal expression of the playwright's idea.

## INSTRUCTIONS

In this chapter of the workbook, you will block French scenes from The Glass Menagerie by Tennessee Williams, The Importance of Being Earnest by Oscar Wilde and finally a number of French scenes from plays selected by your instructor. Emphasis in these exercises is upon the use of blocking to achieve a visual expression of the playwright's idea contained in the script. In order to adequately and intelligently block these scenes, you must first fulfill one of the most important functions of the director: analysis of the script. This analysis should include: (A) a statement of the given circumstances of the play; (B) a one sentence description of the theme of the play; (C) a statement of the central dramatic action of the play; (D) interpretation of the play as a metaphor; (E) interpretation of the spine or motivation of each character appearing in each scene; and a metaphor for important characters in the scenes you are blocking.

For each individual scene, you must also explain: How the scene contributes to the dramatic action of the play as a whole; each character's purpose in the scene; and their purpose in each individual beat within the scene.





3. Previous action (What has happened before the play begins?)

4. Major characters' attitude toward their environment.

B. A One Sentence Statement of the Theme of the Play

Avoid making a moral or literary statement such as "Crime does not pay." You should instead make a theatrical statement as Laurence Olivier did for the film version of Hamlet. He said that the play was about a man who could not make up his mind.

\_\_\_\_\_ is a play about \_\_\_\_\_

---



---

C. What is the Central Action of the Play?

The central action of Oedipus Rex, for example, might be, "to discover the truth at all costs."

The central action of \_\_\_\_\_ is \_\_\_\_\_

---



---

D. Statement of the Play as a Metaphor

This should be an abstract image or possibly an image from nature which comes to mind as you read the play. A commanding image for Oedipus Rex might be, "a blinding light in the distance." (Note how this metaphoric treatment of truth colors the central action of the play. A man searching for the light will nevertheless be repelled by its intensity, regardless how much he wants to reach it.)

What is a commanding image for \_\_\_\_\_?

E. "Spine" or Motivational Force

What does each character want?

1.

2.

3.

4.

5.

F. Metaphor for Individual Characters

Visualize the character as an abstract or natural force.

1.

2.

3.

4.

5.

The Groundplan(s) for the Play

You should first prepare your groundplan in either 1/2 inch or 3/8 inch scale. The groundplan then will be reduced to 1/4 inch scale and drawn on a ditto master. This groundplan will then serve as a workpage when you block each scene.

Workpage

ANALYSIS OF THE SCENE

Central Action of the Scene

Character's Purpose in the Scene

Use verbs (infinitives, i.e. to destroy, to deceive) to express what each character wishes to do in each scene.

(Remember to divide the scene into beats and to analyze each beat individually. Your analysis should be recorded on the workpage opposite each beat.)

Exercise A: "The Glass Menagerie"

Synopsis of the scene. Dinner has been finished and Amanda has taken Tom to the kitchen in order to leave Laura alone with Jim, the Gentleman Caller. In order to draw Laura out of her shell, Jim asks Laura about her present interests.

Jim: Now how about you? Isn't there something you take more interest in than anything else?

Laura: Well, I do--as I said--have my--glass collection--

Jim: I'm not right sure I know what you're talking about. What kind of glass is it?

Laura: Little articles of it, they're ornaments mostly! Most of them are little animals made out of glass, the tiniest little animals in the world. Mother calls them a glass menagerie! Here's an example of one, if you'd like to see it! This one is one of the oldest. It's nearly thirteen.

Jim: I'd better not take it. I'm pretty clumsy with things.

Laura: Go on, I trust you with him! There now--you're holding him gently! Hold him over the light, he loves the light! You see how the light shines through him?

Jim: It sure does shine!

Laura: I shouldn't be partial, but he is my favorite one.

Jim: What kind of thing is this one supposed to be?

Laura: Haven't you noticed the single horn on his forehead?

Jim: A unicorn, huh?

Laura: Mmm-hmmm!

Jim: Unicorns, aren't they extinct in the modern world?

Laura: I know!

Jim: Poor little fellow, he must feel sort of lonesome.

Laura: (Smiling) Well, if he does he doesn't complain about it. He stays on the shelf with some horses that don't have horns and all of them seem to get along nicely together.

Jim: How do you know?

Laura: (Lightly) I haven't heard any arguments among them!

Jim: (Grinning) No arguments, huh? Well, that's a pretty good sign! Where should I put him?

Laura: Put him on the table. They all like a change of scenery once in a while!



Exercise B: "The Importance of Being Earnest"

Synopsis of the scene. Algernon Moncrieff is preparing to receive visitors, namely his aunt, Lady Bracknell, and his cousin, Gwendolen. Prior to their arrival, however, Jack Worthing (Ernest) arrives and talk centers on marriage and Jack's romance with Gwendolen.

Setting. Morning-room in Algernon's flat in Half-Moon Street. The room is luxuriously and artistically furnished.

(Enter Jack)

Algernon: How are you, my dear Ernest? What brings you up to town?

Jack: Oh, pleasure, pleasure! What else would bring one anywhere? Eating as usual, I see, Algy!

Alge: I believe it is customary in good society to take some slight refreshment at five o'clock. Where have you been since last Thursday?

Jack: In the country.

Alge: What on earth do you do there?

Jack: (Pulling off his gloves) When one is in town, one amuses oneself. When one is in the country, one amuses other people. It is excessively boring.

Alge: And who are the people you amuse?

Jack: Oh, neighbors, neighbors.

Alge: Got nice neighbors in your part of Shropshire?

Jack: Perfectly horrid! Never speak to one of them.

Alge: How immensely you must amuse them! By the way, Shropshire is your county, is it not?

Jack: Eh? Shropshire? Yes, of course. Hallo! Why all these cups? Why cucumber sandwiches? Why such reckless extravagance in one so young? Who is coming to tea?

Alge: Oh! Merely Aunt Augusta and Gwendolen.

Jack: How perfectly delightful!

Alge: Yes, that is all very well; but I am afraid Aunt Augusta won't quite approve of your being here.

Jack: May I ask why?

Alge: My dear fellow, the way you flirt with Gwendolen is perfectly disgraceful. It is almost as bad as the way Gwendolen flirts with you.

Jack: I am in love with Gwendolen. I have come up to town expressly to propose to her.

Alge: I thought you had come up for pleasure? . . . I call that business.

Jack: How utterly unromantic you are!

Alge: I really don't see anything romantic in proposing. It is very romantic to be in love. But there is nothing romantic about a definite proposal. Why, one may be accepted. One usually is, I believe. Then the excitement is all over. The very essence of romance is uncertainty. If ever I get married, I'll certainly try to forget the fact.

Jack: I have no doubt of that, dear Algy. The Divorce Court was specially invented for people whose memories are so curiously constituted.

Alge: Oh! There is no use speculating on that subject. Divorces are made in Heaven--Please don't touch the cucumber sandwiches. They are ordered specially for Aunt Augusta.

Jack: Well, you have been eating them all the time.

Alge: That is quite a different matter. She is my Aunt. Have some bread and butter. The bread and butter is for Gwendolen. Gwendolen is devoted to bread and butter.

Jack: And very good bread and butter it is, too.

Alge: Well, my dear fellow, you need not eat as if you were going to eat it all. You behave as if you were married to her already. You are not married to her already, and I don't think you ever will be.

Jack: Why on earth do you say that?

Alge: Well, in the first place girls never marry the men they flirt with. Girls don't think it right.

Jack: Oh, that is nonsense!

Alge: It isn't. It is a great truth. It accounts for the extraordinary number of bachelors that one sees all over the place. In the second place, I don't give my consent.

Jack: Your consent!

Alge: My dear fellow, Gwendolen is my first cousin. And before I allow you to marry her, you will have to clear up the whole question of Cecily.  
(Rings bell)

Exercise C: Play Title

---

Scenes.

Exercise D: Play Title

---

Scenes.

Exercise E: Play Title

---

Scenes.

## CHAPTER VII

### CONCLUSIONS

The basic problem of this thesis was to construct a set of exercises which would (1) provide the student with the opportunity to learn by doing--by actually blocking simple stories or scenes from existing plays-- and (2) to create a teaching tool which would allow the student to begin at his own level of skill, progress at his own pace and to review his work periodically.

To determine the content and nature of these exercises, existing textbooks specifically designed for the beginning director were analyzed to determine how experienced teacher-directors proposed to develop blocking skills, the writings of acknowledged master directors were surveyed to ascertain how they achieved success in their blocking and actual productions were observed to view how beginning directors either succeeded or failed in actual practice and to identify the problems they incurred.

As a result of this study, the requisite blocking skills which must be developed were identified as composition and picturization and movement.

Consequently, two chapters in the workbook were devoted to their study and practice. In addition, this study indicated that play analysis and design of the groundplan are necessary antecedents to meaningful blocking and must be considered related skills which must be developed.

Although this workbook is constructed according to current directing and educational theory, it is yet untested in actual practice. Since the only means of testing any textbook or workbook is to apply it in a learning situation and then evaluate how well it accomplishes its stated objectives, it is not possible to assess the effectiveness of the workbook as a teaching tool at this time.

The validity of a workbook approach to teaching directing techniques is somewhat substantiated, however, by publication of a director's workbook by Stanley Kahan and Harry E. Stiver. Although the Stiver-Kahan workbook includes exercises in blocking, their workbook is intended to cover the total directing process from play selection through characterization. The sections on blocking in their workbook offer extensive (as opposed to the more intensive approach taken in this workbook) work on the French scene. Examination of the exercises they provide indicates that they are excellent

for the intermediate director, but may well be too difficult for the student with little or no training or experience. Since the exercises are more general, begin at a more advanced stage of development and require the student to concentrate on more than one skill at a time, the inexperienced student may tend to become confused or lost. For the more advanced student, however, the extensive scene work provided in the Kahan-Stiver book offers an excellent sequel to the intensive scene work provided in this book.

Although both workbooks, used either separately or in conjunction with one another, will provide opportunities for the student to develop basic blocking skills, a need still exists for a workbook(s) which would concentrate upon the specialized problems of blocking for the arena and/or thrust stages. Presumably, since theorists agree that blocking for the arena and thrust stages involves a variation and adaptation of proscenium blocking techniques, a workbook in this area would be written for the intermediate or advanced student and used after completion of this and the Stiver-Kahan book.

## APPENDIX

### READING LIST

Before the student begins work on the exercises, he should be required to read the following plays:

Hedda Gabler by Henrik Ibsen

The Importance of Being Earnest by Oscar Wilde

The Glass Menagerie by Tennessee Williams

The Cherry Orchard by Anton Chekov

These plays should be available in your local or College Library or in your campus bookstore.



## BIBLIOGRAPHY

- Bentley, Eric. The Theory of the Modern Stage. Middlesex, England: Penguin Books, 1968.
- Braun, Edward (ed.). Meyerhold on Theatre. New York: Hill and Wang, 1969.
- Brown, Gilmore, and Garwood, Alice. General Principles of Play Directing. New York: Samuel French, 1936.
- Cameron, Kenneth M., and Hoffman, Theodore J. C. The Theatrical Response. n.p.: Macmillan Co., 1969.
- Canfield, Curtis. The Craft of Play Directing. New York: Holt, Rinehart and Winston, 1963.
- Carter, Conrad; Bradbury, A. J.; and Howard, W. R. B. The Production and Staging of Plays, New York: Arc Books, 1963.
- Clay, James H., and Krempel, Daniel. The Theatrical Image. New York: McGraw-Hill Book Company, 1967.
- Cole, Toby, and Chinoy, Helen Krich. Directing the Play. Indianapolis: Bobbs-Merrill Company, 1953.
- \_\_\_\_\_. (ed.). Directors on Directing. Indianapolis: Bobbs-Merrill Company, 1963.
- Crafton, Allen, and Royer, Jessica. The Complete Acted Play from Script to Curtain. New York: F. S. Crofts & Co., 1943.
- Crampton, Esme. A Handbook of the Theatre. Canada: W. J. Gage, 1964.
- Dean, Alexander, and Carra, Lawrence. Fundamentals of Play Directing. New York: Holt, Rinehart and Winston, 1965.

- Dukore, Bernard F. Bernard Shaw, Director. Seattle: University of Washington, 1971.
- Durrenmatt, Friedrich. The Visit. Translated by Patrick Bowles. New York: Grove Press, 1956.
- Fergusson, Francis. The Idea of a Theater. Princeton, N. J.: Princeton University Press, 1949.
- Gallaway, Marian. The Director in the Theatre. New York: Macmillan Company, 1963.
- Gassner, John. Producing the Play. New York: The Dryden Press, 1941.
- \_\_\_\_\_. Theatre at the Crossroads. New York: Holt, Rinehart and Winston, 1960.
- Gorchakov, Nikolai M. Stanislavsky Directs. Translated by Miriam Goldina. n.p.: Minerva Press, 1954.
- Gorelik, Mordecai. New Theatres for Old. New York: E. P. Dutton & Co., 1962.
- Gregory, W. A. The Director, A Guide to Modern Theater Practice. New York: Funk & Wagnalls.
- Heffner, Hubert C.; Selden, Samuel; and Sellman, Hunton D. Modern Theatre Practice. 5th ed. New York: Appleton-Century-Crofts, 1973.
- Hewitt, Barnard. Art and Craft of Play Production. Chicago: J. B. Lippincott Company, 1940.
- Hodge, Francis. Play Directing. Englewood Cliffs, N.J.: Prentice-Hall, 1971.
- Hunt, Hugh. The Director in the Theatre. London: Routledge and Kegan Paul, 1954.
- Ibsen, Henrik. Six Plays by Henrik Ibsen. Translated by Eva Le Gallienne. New York: Modern Library, 1957.
- Johnson, Albert, and Johnson, Bertha. Directing Methods. London: A. S. Barnes & Company, 1970.

- Kahan, Stanley, and Stiver, Harry E. Jr. A Director's Workbook. Dubuque, Iowa: Wm. C. Brown Company, 1974.
- LeCompte, Pearle. Dramatics. New York: A. S. Barnes & Company, 1931.
- Leonard, Charles (ed.). Michael Chekov's to the Director and Playwright. New York: Harper & Row, 1963.
- McMullan, Frank. The Directorial Image: The Play and the Director. Hamden, Conn.: Shoe String Press, 1962.
- \_\_\_\_\_. The Director's Handbook. Hamden, Conn.: Shoe String Press, 1964.
- Marshall, Norman. The Producer and the Play. London: Macdonald & Co., 1957.
- Nelms, Henning. Play Production. New York: Barnes and Noble, 1958.
- Roose-Evans, James. Directing a Play. New York: Theatre Arts Books, 1968.
- Secondary School Theatre Conference of the American Educational Theatre Association. Course of Study. n.p.: American Educational Theatre Association, 1963.
- Shakespeare, William. Macbeth. Edited by Louis B. Wright and Virginia A. LaMar. New York: Washington Square Press, 1959.
- Sievers, W. David. Directing for the Theatre. Dubuque, Iowa: Wm. C. Brown Company, 1965.
- Spolin, Viola. Improvisation for the Theater. Evanston, Ill.: Northwestern University Press, 1963.
- Stanislavski, Constantin. Creating a Role. Translated by Elizabeth Reynolds Hapgood. New York: Theatre Arts Books, 1961.
- Welker, David. Theatrical Direction: The Basic Techniques. Boston: Allyn & Bacon, 1971.

Young, John Wray. Directing the Play. New York:  
Harper & Brothers, 1958.

Young, Stark. The Theatre. New York: Hill and Wang,  
1954.

\_\_\_\_\_. Theatre Practise. New York: Charles  
Scribner's Sons, 1926.